



BEVERAGE-AIR®

INSTALLATION AND OPERATING INSTRUCTIONS for RBS Blast Chiller Models



809-159A Rev. D. 02/10/2026

3779 CHAMPION BLVD, WINSTON-SALEM, NC 27105

Phone: (888) 845-9800 | Fax: (800) 253-5168 | Web: beverage-air.com

**SEE BACK COVER FOR
WARRANTY REGISTRATION**



WELCOME

Thank you for purchasing a Beverage-Air cabinet. This series has passed our strict quality control inspection and meets the high standards set by Beverage-Air Refrigeration! You have made a quality investment that with proper maintenance will give you many years of reliable service!

Please read the following installation and maintenance instructions before installing or using your unit.

Important Information

- PLEASE READ THESE INSTRUCTIONS CAREFULLY BEFORE INSTALLING OR USING, IF RECOMMENDED PROCEDURES ARE NOT FOLLOWED, WARRANTY CLAIMS MAY BE DENIED.
- Your warranty registration information is located within this manual. Please complete the card and submit it to Beverage-Air Refrigeration within TEN days of installation. Failure to properly register equipment may limit or void the warranty.
- Beverage-Air Refrigeration reserves the right to change specifications and product design without notice. Such revisions do not entitle the buyer to corresponding changes, improvements, additions, or replacements for previously purchased equipment.
- THE MANUFACTURER DECLINES LIABILITY FOR NON-DECLARED USE OF THE PRODUCT. THE REPRODUCTION OF THIS MANUAL OR ITS PARTS THEREOF, IS PROHIBITED.

CONTENTS

Safety	3
Important Information	4
Product Information	5
Electrical	6
Using the Controller/Initial Settings	7
Device Transport and Installation	11
Maintenance and Disposal	16
Methods For Cleaning Stainless Steel.....	17
Instructions for Using the Equipment Safely.....	18
Service and Repairs.....	31
For the Service Tech - Technical Data	32
For the Service Tech - Wiring Diagrams.....	34
Limited Warranty	42
Limited Warranty (continued).....	43

SAFETY

This appliance has been designed with your safety in mind. It has many features to keep you from being harmed. However, safe operation and maintenance are your responsibilities.



Use: When using this unit, please:

- **Move it carefully.** If on casters be sure the casters do NOT run over the power cord.
- **Lock** the casters when in use.
- **Seek help.** This machine is heavy! Be sure to move with enough help to avoid tipping or dropping the cabinet.
- **Prevent children from playing in or on the cabinet.** Persons unable to use this product must be prevented access.
- **Follow all instructions.** There are many safety labels and directions on the unit. Heed them.
- **Watch your fingers.** There may be pinch points near the door hinges.



Maintenance

Do NOT:

- Clean a frozen evaporator with a sharp object
- Clean a dirty condenser with a sharp object.
- Store gasoline, kerosene or any other flammable material near the cabinet.

Do ALWAYS

- Use a Beverage-Air recommended technician certified to repair R290 equipment.
- Use ONLY Beverage-Air factory service parts. Use of non OEM parts can be dangerous because of the design changes needed to safely use R290.
- Wear gloves to perform maintenance on the motor components or the evaporating unit inside the machine.

Important Information to Add

Record the model number, serial number and the date of installation here for future reference. The model and serial numbers are on the unit's serial number dataplate, which is located on the left inside wall.

Model Number	
Serial Number	
Date of Installation	
Purchased From	



Observe the **Caution** and **Warning** notices. They are indicators of important safety information. Keep this manual for future reference.

IMPORTANT INFORMATION

This unit is intended to be used in a commercial application. That includes bars and restaurants.

If installed in a residence some commercial service companies may not be able to service it on site.

The manufacturer has designed and produced this machine with the finest in materials. The manufacturer assumes no liability for units that have been altered in any way. Alterations or part substitutions will void the warranty.

Limitations

The machine is designed for use indoors in a controlled environment. It must be kept dry, not overheated or subjected to excessive cold. May only be connected to a dedicated electrical circuit. Extension cords are not permitted.

	Minimum	Maximum
Voltage	208	240
Room Air Temp	60° F	104° F

Air Flow

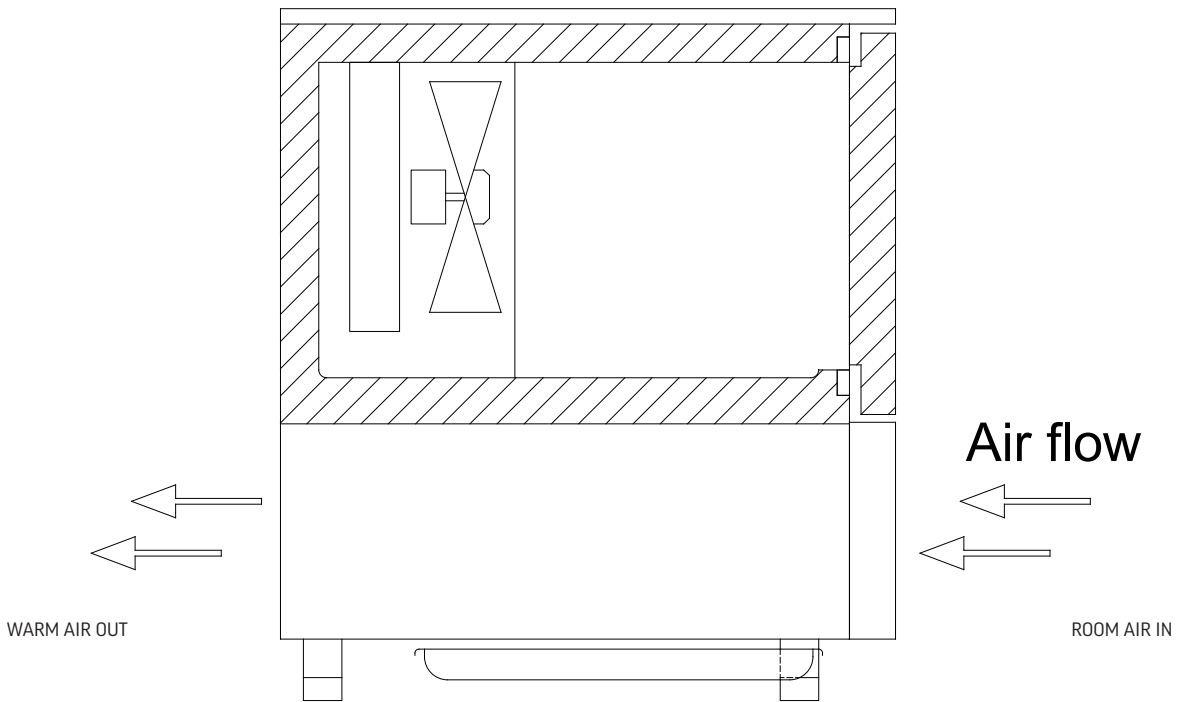

Agency Approvals

These marks appear on the dataplate or serial tag, located in the inside of the left wall. The dataplate also contains the model and serial numbers as well as electrical requirements.



PRODUCT INFORMATION

Model	Cabinet Dimensions w x d x h (Inches)	Door Count	Full Load Amps	Compressor HP	R-290 Refrigerant/ Charge (g) / (oz)	BTU/Hr (113°F/-13°F)	BTU/Hr (104°F/-14°F)	Voltage	NEMA Plug
Reach In (Self Contained)									
RBS-054-SA-HC	33.46 X 34.65 X 35.43	1	6.6	1	N/A / N/A	2985	6033	208-240/60/1	6-15P
RBS-122L-SA-HC	33.46 X 39.37 X 71.26		9.0	2	N/A / N/A	7208	15252	208-240/60/3	15-20P
RBS-162-SA-HC	33.46 X 39.37 X 77.17		13.2	2 1/2	N/A / N/A	9154	19485		

Height includes legs.

- Blast Chilling Cycle rapidly lowers the temperature of the contents from 194°F to 37°F in 90 minutes
- Shock Freezing Cycle lowers the temperature from 194°F to 0°F in 240 minutes
- **ALWAYS REFERENCE YOUR EQUIPMENT DATA PLATE AMPS, REFRIGERANT AND REFRIGERANT CHARGE FOR THE MOST UP TO DATE AND ACCURATE VALUES.**

ELECTRICAL

The self-contained models are cord-connected units, and must be connected to their own **dedicated** power supply. Check the dataplate on the machine to confirm the voltage and per the dataplate use the correct fuses or HACR circuit breakers.

Note: Do not connect to GFI / GFCI outlets. Connection to that type of outlet can result in product loss due to unsafe cabinet temperature when GFI device trips from moisture.

Power Cord

The voltages and plug type will vary by model, please check the data plate for confirmation.

If the power cord becomes damaged, it must be replaced with the identical cord.

Follow All National and Local Codes

This Unit Must Be Grounded. Do not use extension cords and do not disable or by-pass ground prong on electrical plug.

Initial Start Up

Plug the power cord into the proper power supply.

The cabinet will soon begin to blow warm air out of the front grille area, and cool air will flow from the inside blower.

Cautions

Care must be taken whenever moving or servicing the unit. The refrigerant is contained in a sealed system, but if released it is flammable.

USING THE CONTROLLER/INITIAL SETTINGS

TURNING ON AND OFF

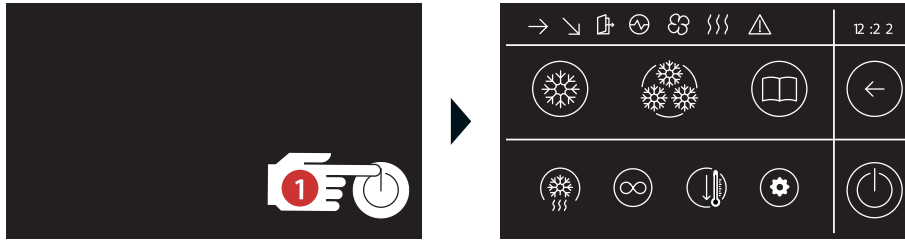

SETTING LANGUAGE, DATE, AND TIME

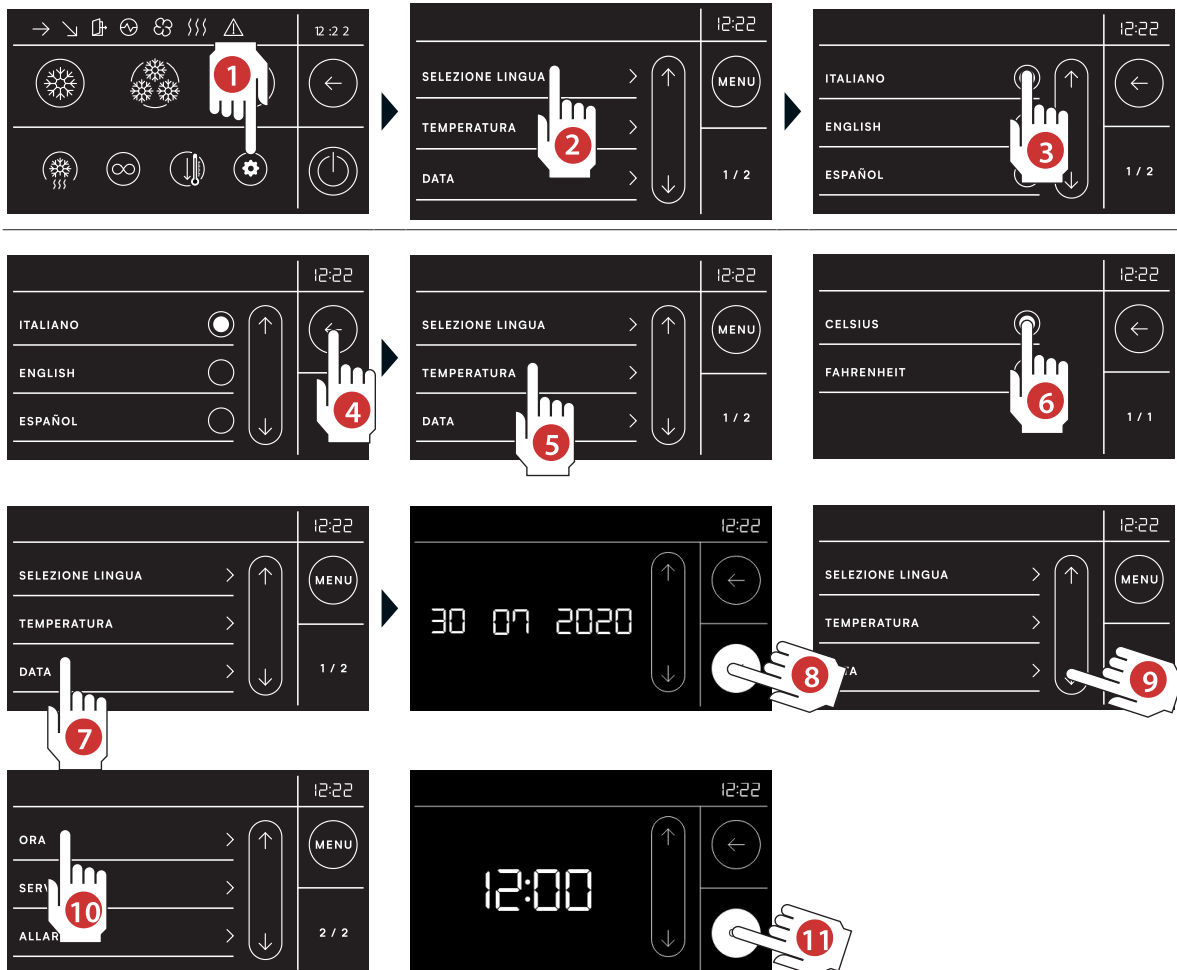

POSITIVE (1A) OR NEGATIVE (1B) ABATEMENT WITH AUTOMATIC OR MANUAL CYCLES

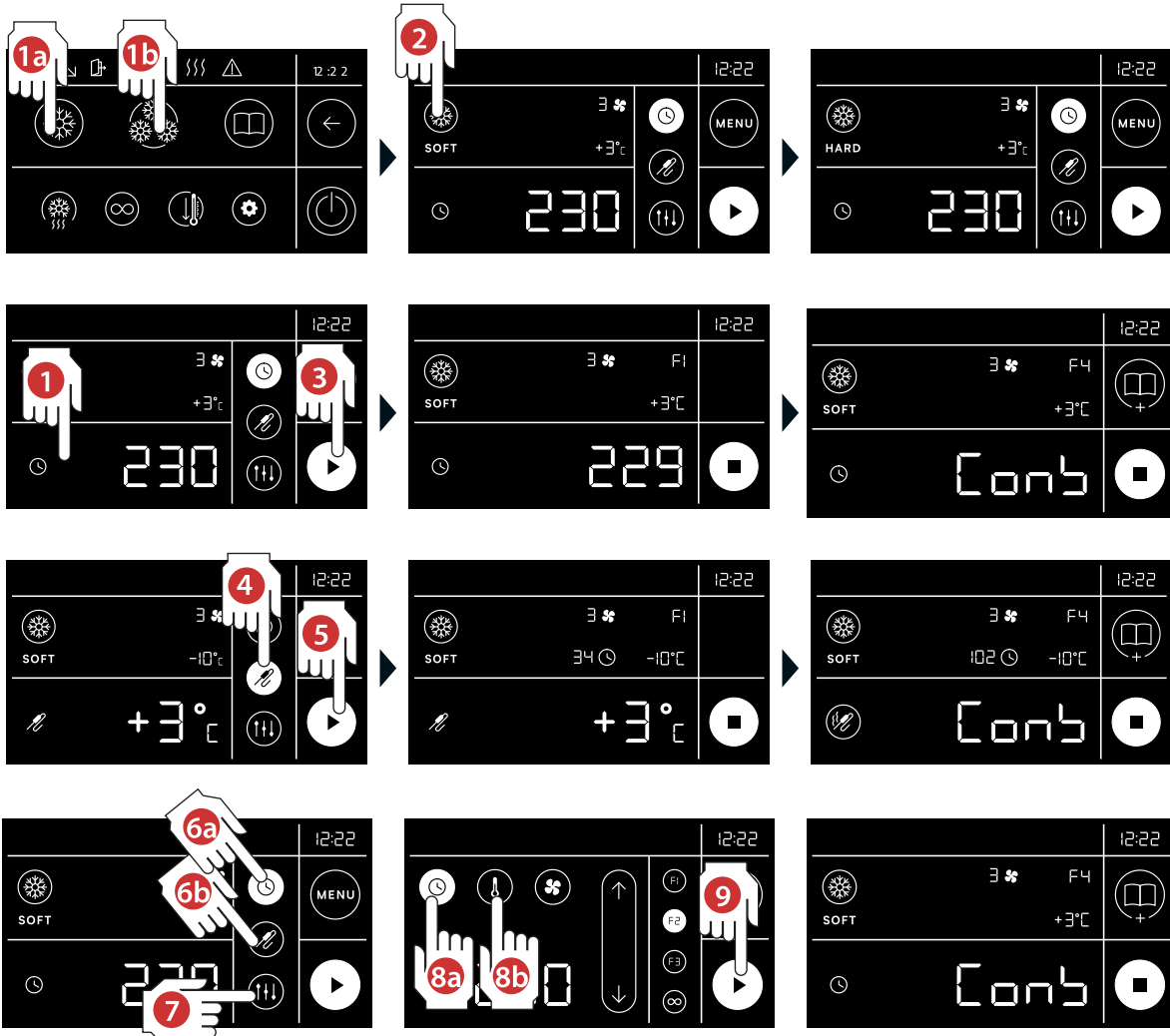

SAVING THE COMPLETED CYCLE

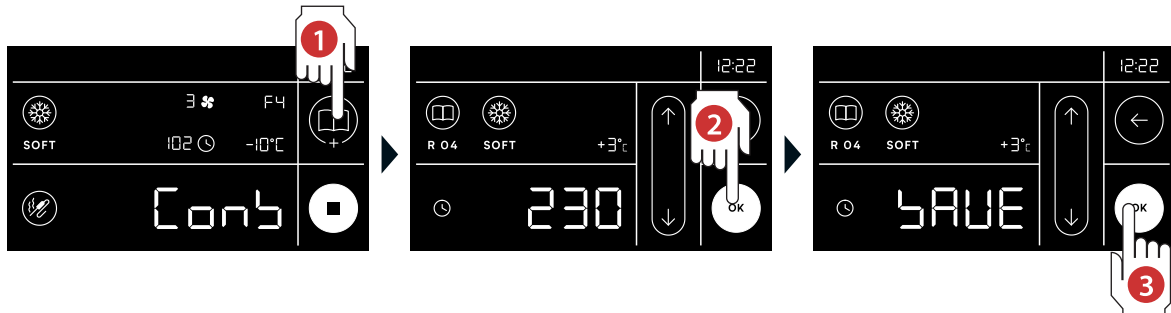

NEEDLE PROBE HEATING

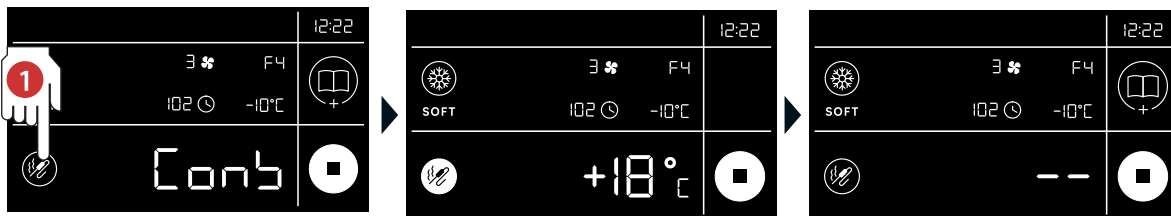

CONTINUOUS CYCLE

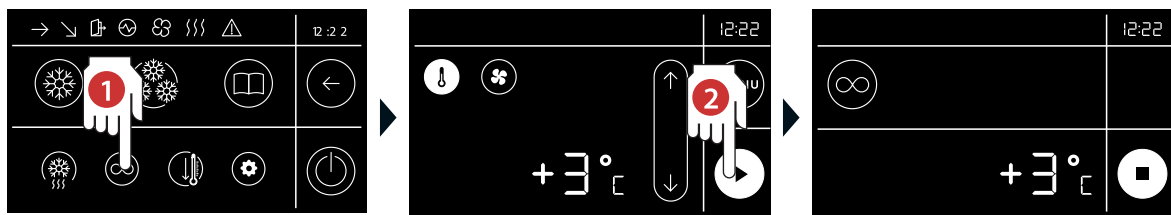

PRE-COOLING

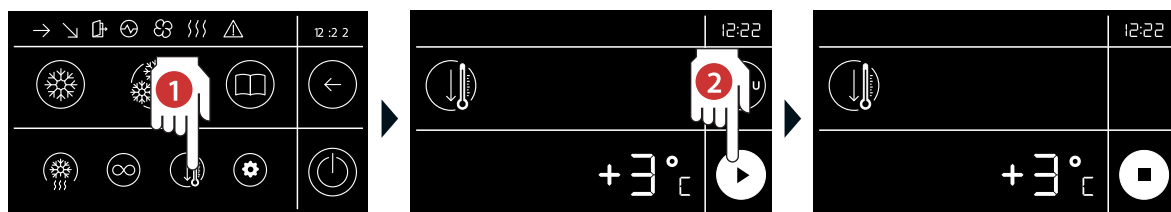

OPEN DOOR AIR DEFROSTING



USE OF PRESET RECIPES FOR POSITIVE (1A) OR NEGATIVE (1B) ABATEMENT CYCLES

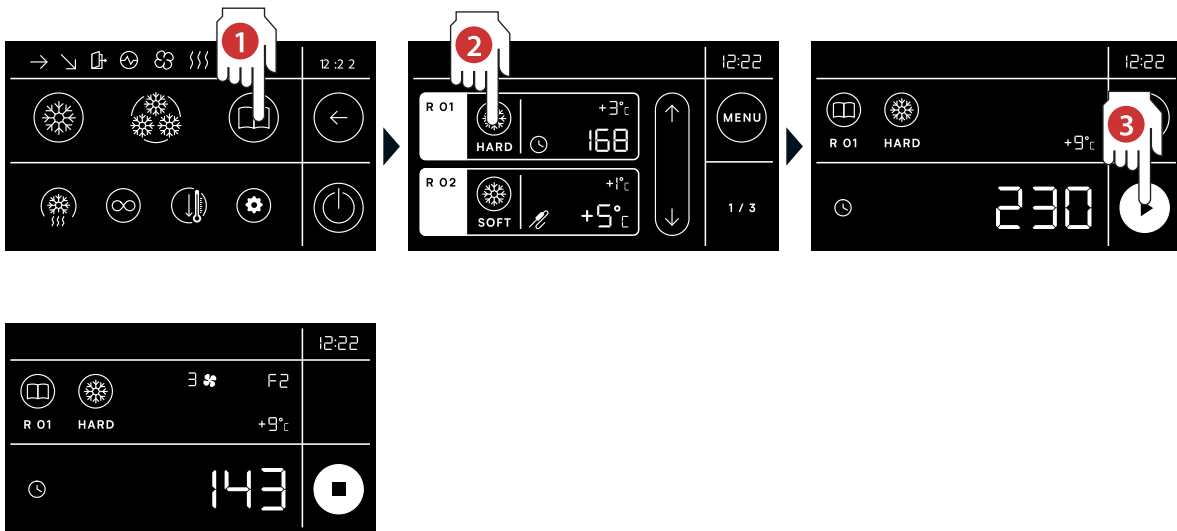

DEVICE TRANSPORT AND INSTALLATION

Device transport and handling must be done exclusively as follows. Keep the packaging in the vertical position as per the indications printed on it. This precaution is necessary to prevent the oil contained in the compressor from circulating, which could break the valves and cause problems while starting the motor.

After unpacking, when moving the device, do not push or pull it in order to avoid the risk of overturning or damaging some parts (for example the feet). Never tilt the device from the door side.

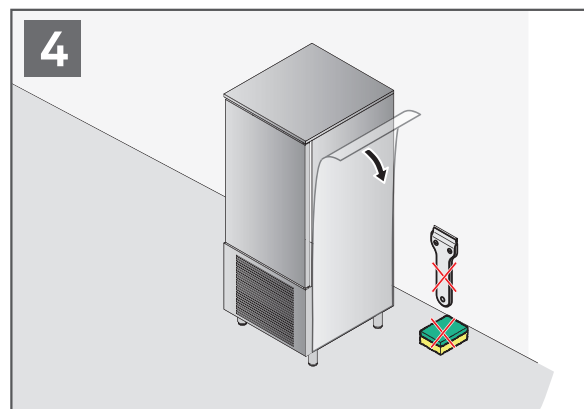
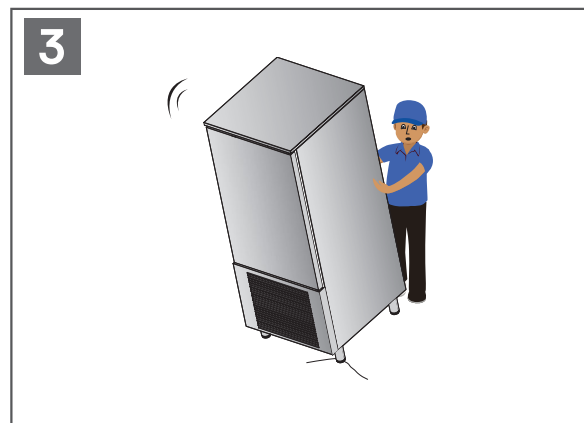
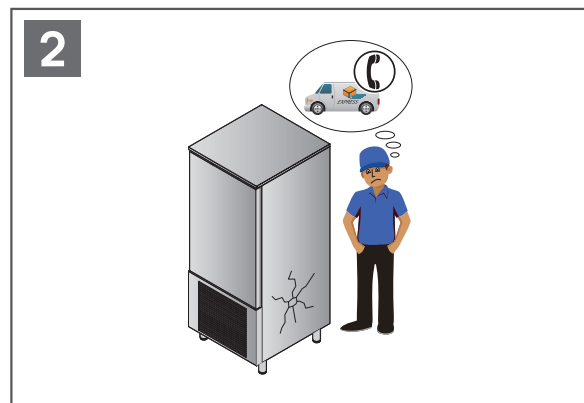

During installation and positioning, appliances without support feet must be sealed to the lower support surface to ensure compliance with hygiene standards in accordance with the requirements of the country of destination/installation. Figure 5.

Seal the perimeter of the support base using silicone sealant free of carcinogen substances and compliant with NSF-FDA requirements, and/or in compliance with the requirements of the country of destination. Contact surfaces must be thoroughly cleaned and degreased before applying the sealant. Check that the supporting surfaces are level to ensure the appliance is installed flat. If there are any embossed surfaces, take extra care when sealing the appliance to ensure that the product penetrates properly and fills any gaps or apertures.

Sealing the appliance in accordance with the above procedures ensures that any accidental liquid spillage/leakage onto adjacent surfaces does not penetrate into the inaccessible part of the appliance underneath.

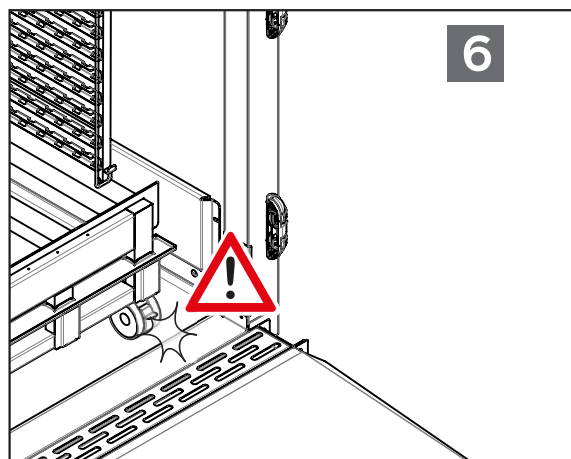
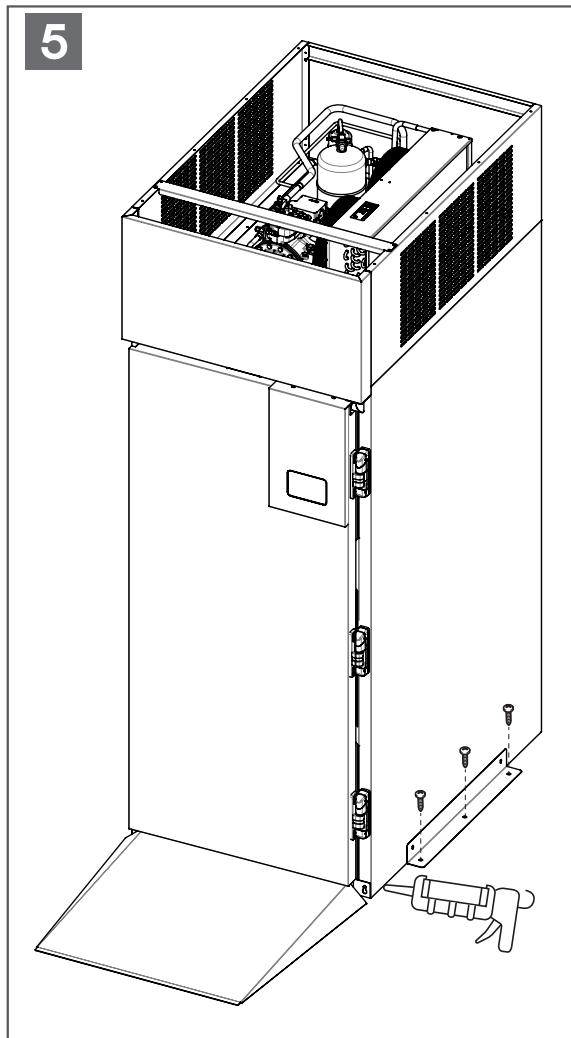

There must be:

A: a circuit breaker with high sensitivity, adequately sized

B: a point of connection to the power mains

C: a point of connection to the water mains (only for water-cooled appliances in case of connection to the water mains) to comply with the pressures available on the water networks.

If necessary, install a special pressure reducer on the fixed system, upstream of the appliance. The device indicated must be installed in accordance with the regulations in force in the countries of destination and considering the requirements of the EN 60335-1:2012 standard and respective amendments (including A14:2019). In case of clarifications, indications on the choice of the reducer and any other requirement, contact technical support.

D: a point of discharge (optional)

The machines must be positioned on the ground only, on floors that are:

- Not sensitive to heat or flammable
- Perfectly leveled
- With a regular surface and free of roughness
- That can support the device at full load

Keep the illustrated minimum clearances around the device to facilitate connections to utilities and maintenance.

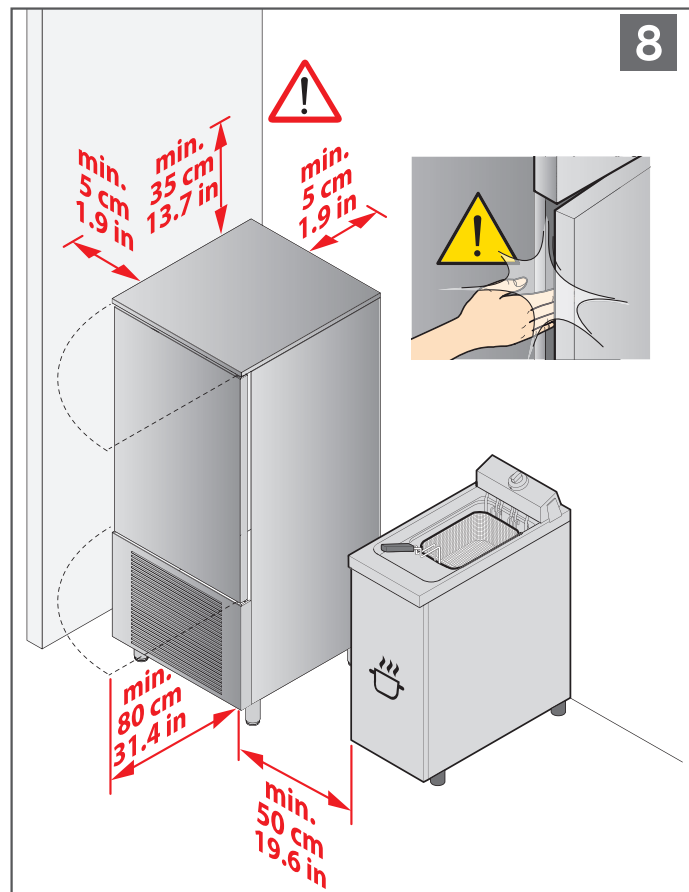
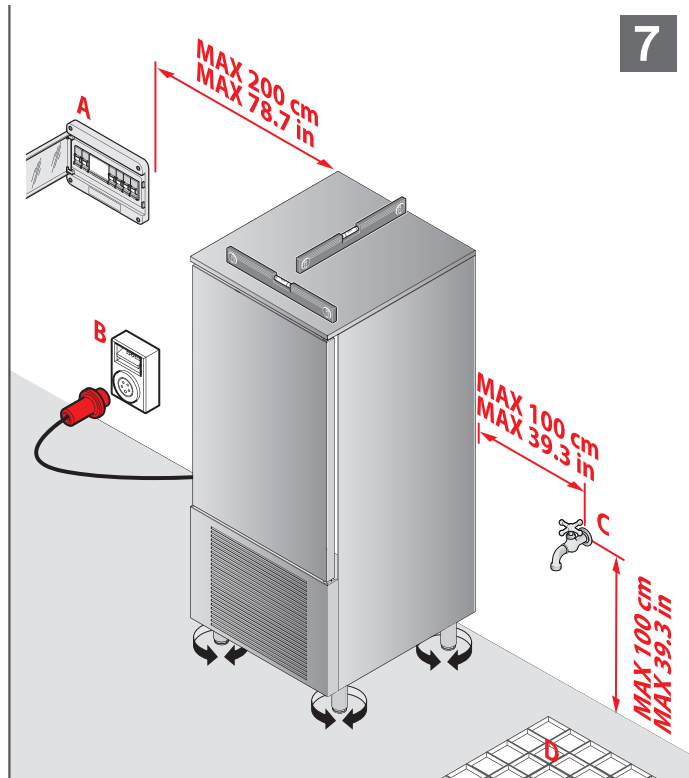

These devices require ventilation at the back where the vents and coolant unit are found. Therefore, do not place them against the wall but keep them approximately 5cm (2") away.

In order to prevent accidentally moving the equipment too close to the wall, make sure to install the provided spacers on the back of the device (especially if the device is assembled on wheels).

POWER CONNECTIONS

⚠ CONNECTIONS TO THE MAINS AND CONNECTION PLANTS MUST COMPLY WITH THE LEGAL PROVISIONS IN FORCE IN THE COUNTRY OF INSTALLATION AND MUST BE PERFORMED BY QUALIFIED PERSONNEL AUTHORIZED BY THE MANUFACTURER.

In order to avoid any risks, damaged power supply cables must be replaced by the Manufacturer, by an approved technical support center, or in any case by an individual with similar qualifications.

Before connecting the device to the mains:

- read the safety instructions at the beginning of this manual
- make sure the mains voltage and frequency correspond to those indicated in the device serial number plate. A rated voltage variation of +/- 10% is accepted.

THE DEVICE MUST BE CONNECTED TO AN EFFICIENT GROUND SOCKET. ⚡ THE DEVICE MUST INCLUDE AN EQUIPOTENTIAL SYSTEM COMPLIANT TO THE LEGAL PROVISIONS IN FORCE (YELLOW GREEN CONDUCTOR WITH A MAXIMUM SECTION OF 10 MMQ - CEI EN 60335-2-89 NORM). THIS CONNECTION MUST BE MADE BETWEEN THE VARIOUS DEVICES WITH THE TERMINAL MARKED WITH THE EQUIPOTENTIAL SYMBOL. ⚡

For mains connections, use a circuit breaker with manual reset high sensitivity (30mA), with adequate power that permits complete cut-off in over voltage category III conditions, in order to protect the device against over voltages or short circuits.

For the sizing of the protection device, please refer to the technical data table in this manual.

The single phase appliances leave the factory with the power cable and an Unel plug already installed on the terminal block: it is not allowed to make any other type of electrical connection and no dimensional modification of the cable other than its lengthening, replacing it with one having the same characteristics as the original one (rubber type, section, etc.).

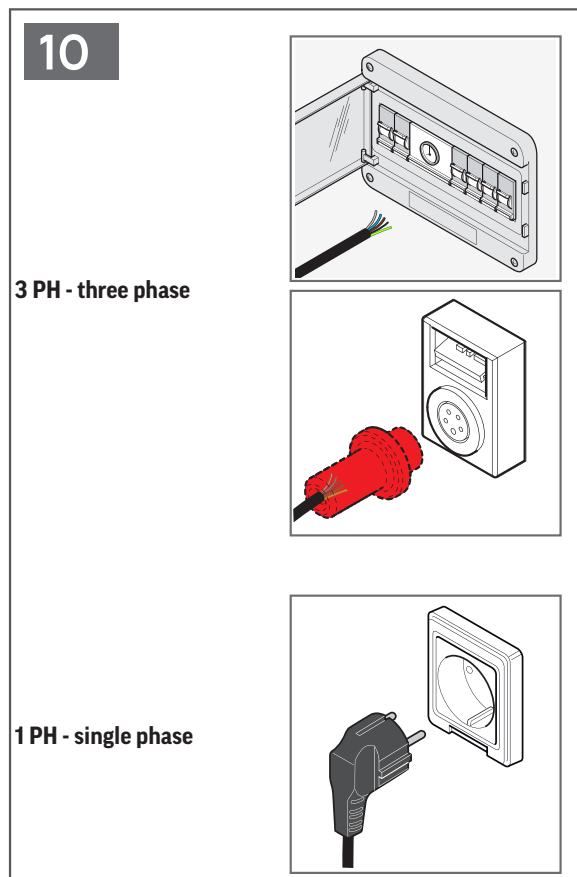
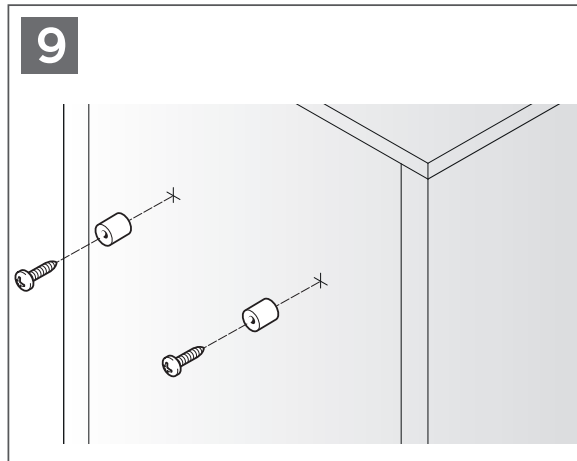

The three-phase appliances leave the factory with the power cable already installed on the terminal block: fit an electric plug (not supplied) of a type and capacity suitable for the maximum current absorbed by the phases of the appliance or make a direct connection to an electrical panel.

WATER CONNECTIONS - OUTLET WATER

Cleansing water is collected in a tank which is under the machine. We recommend you connect the drain to a maximum 200 cm (78.7") in long hose (not supplied) and lead it to a grate in the floor or wall drain pipe, to avoid emptying the tank too frequently. The drain pipe must have the following characteristics:

- is of trap type
- has a minimum inclination of 4%
- has an air gap* of at least 25mm (1 in)
- does not have clamps
- has a diameter not under that of the drain pipe joint

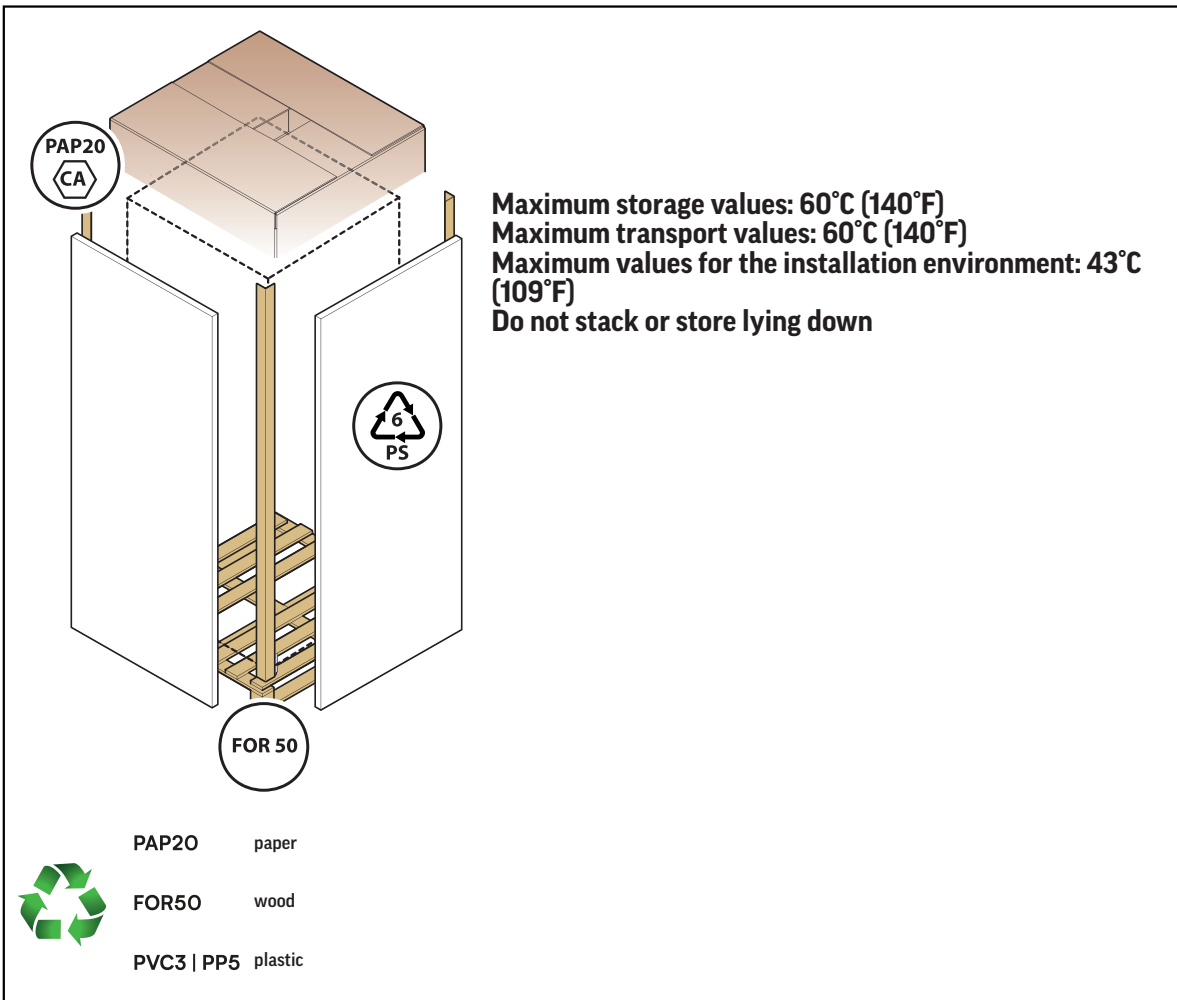
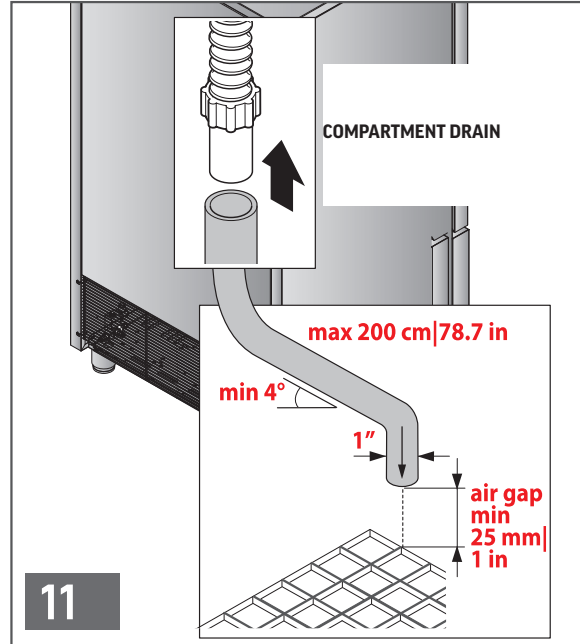

MAINTENANCE AND DISPOSAL

MAINTENANCE

Before performing any maintenance, cut off the power supply to the machine and wear suitable personal protection equipment (e.g. gloves, etc.).

To clean any component or accessory, **DO NOT** use:

- abrasive or powder detergents
- aggressive or corrosive detergents (e.g. hydrochloric or sulphuric acid, caustic soda, etc.). **Warning!** Do not even use these substances to clean the floor under the equipment
- abrasive or sharp tools (e.g. abrasive sponges, scrapers, steel brushes, etc.).
- steamed or pressurized water jets

DISPOSAL AND END OF SERVICE LIFE

As per Legislative Decree no. 49 art. 13 dated 2014 "Implementation of WEEE Directive 2012/19/EU on electric and electronic waste"

The Barred bin markings specify that the product was issued on the market after August 13, 2015 and should not be assimilated with other waste that at the end of its working life but disposed of separately. All equipment is made of recyclable metallic materials (stainless steel, iron, aluminum, galvanized sheet metal, copper, etc.) in percentages over 90% in weight.

Put the equipment out of order for disposal removing the power cord and any compartment or chamber lock devices (where applicable).

Pay attention to managing this product at the end of its working life, reducing negative impacts on the environment and improving resource use efficiency, applying the "who pollutes, pays", prevention, reuse, recycling, and recovery preparation principles.

Please remember that illicit or incorrect product disposal is punishable by law

If you want to dispose of this appliance, we recommend you contact your local authority or dealer for information on the correct disposal method.

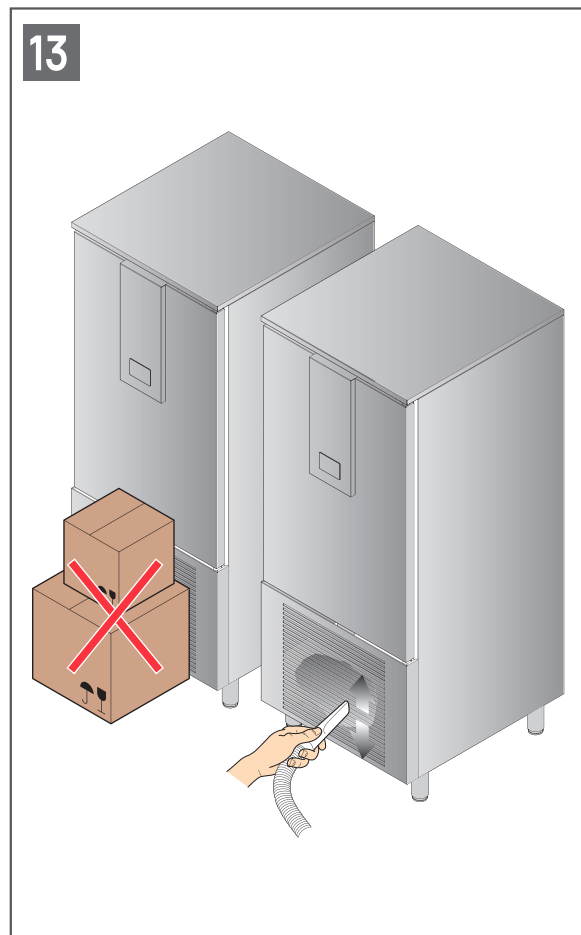
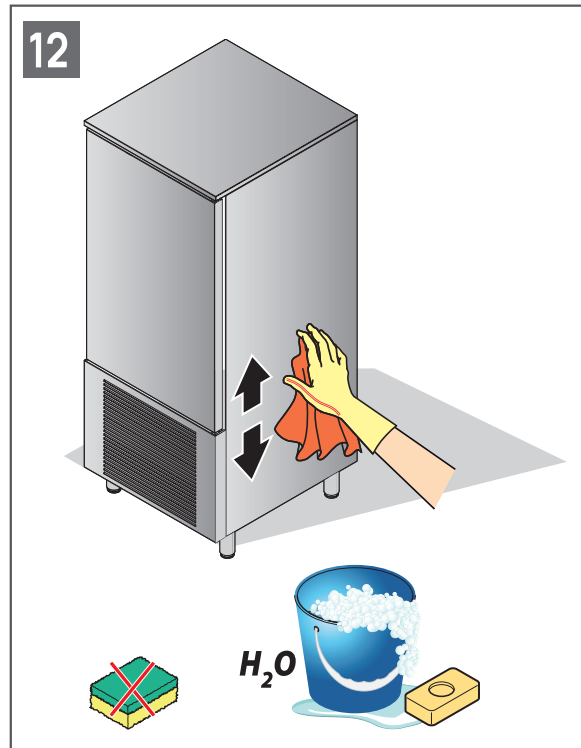

METHODS FOR CLEANING STAINLESS STEEL

Cleaning Needed	Cleaning Agent	Method of Application	Affect on Finish
Smears and fingerprints	Areal 20, Lac-O-Nu, Lumin Wash O' Cedar Cream Polish, Stainless Shine.	Rub with cloth as directed on the package.	Satisfactory for use on all finishes. Provides barrier film to minimize prints.
Stubborn Spots and Stains, Baked-On Splatter, and Other Light Discolorations	Allchem Concentrated Cleaner.	Apply with damp sponge or cloth. Rub with damp cloth.	Use in direction of polish lines on No. 4 (polished) finish. May scratch No. 2 (mill) and Nos. 7 and 8 (polished) finishes.
	Samae, Twinkle or Cameo Copper Cleaner	Rub with damp cloth.	
	Grade FFF Italian pumice, whiting, or talc.	Rub with dry cloth.	
	Liquid NuSteel Paste NuSteel or DuBois Temp. Copper's Stainless Steel Cleaner Revere Stainless Cleaner Household cleansers, such as Old Dutch, Lighthouse, Sunbrite, Wyandotte, Bab-O, Gold Dust, Sapolio, Bon Ami, Ajax, or Comet Grade F Italian Pumice, Steel Bright, Lumin Cleaner, Zud, Restore, Sta-Clean, or Highlite. Penny-Brite or Copper-Brite.	Use small amount of cleaner. Rub with dry cloth using a small amount of cleaner. Apply with damp sponge or cloth. Rub with a damp cloth. May contain chlorine bleaches. Rinse thoroughly after use. Rub with a damp cloth. Rub with a dry cloth using a small amount of cleaner.	
Heat tint or discoloration	Penny-Brite or Copper-Brite. Past NuSteel, DuBois Temp, or Tarnite. Revere Stainless Steel Cleaner. Allen Polish, Steel Bright, Tenacious Deposits, Rusty Discolorations, Industrial Atmospheric Stains Wyandotte, Bab-O or Zud.	Rub with a dry cloth. Rub with a dry cloth or stainless steel wool. Apply with damp sponge or cloth. Rub with a damp cloth.	
Burnt-On Foods and Grease Fatty Acids, Milkstone (where swabbing or rubbing is not practical)	Easy-Off, De-Grease-It, 4 to 6% hot solution of such agents as trisodium phosphate or sodium tripolyphosphate or 5 to 15% caustic soda solution	Apply generous coating. Allow to stand for 10-15 minutes. Rinse. Repeated application may be necessary.	Excellent removal, satisfactory for use on all finishes.
Tenacious Deposits, Rusty Discolorations, Industrial Atmospheric Stains	Oakite No. 33, Dilac Texo 12, Texo NY, Flash-Klenz, Caddy Cleaner, Turco Scale 4368 or Permag 57.	Swab and soak with clean cloth. Let stand 15 minutes or more according to directions on package, then rinse and dry.	Satisfactory for use on all finishes
Hard Water Spots and Scale	Vinegar. 5% oxalic acid, 5% sulfamic acid, 5 to 10% phosphoric acid, or Dilac, Oakite No. 33, Texo 12, Texo N.Y.	Swab or wipe with cloth. Rinse with water and dry. Swab or soak with cloth. Let stand 10-15 minutes. Always follow with neutralizer rinse, and dry.	Satisfactory for all finishes. Satisfactory for all finishes. Effective on tenacious deposits or where scale has built up.







INSTRUCTIONS FOR USING THE EQUIPMENT SAFELY

RECIPIENTS OF THIS MANUAL

This manual provides users of the machine **with all the information necessary for its use and routine maintenance**. Before each operation, **carefully read** the instructions and warnings contained in the manual as they provide essential safety indications. The manual is **an integral part** of the machine and must accompany it throughout its life cycle. In case of transfer of the machine, the manual must be provided to the new owner. In case of loss or damage, request a copy from the Manufacturer, specifying the model of the machine to which it refers. This manual refers to a blast chiller, an appliance capable of lowering quickly the temperature of the food introduced, whether fresh or cooked.

SYMBOLS USED WITHIN THE MANUAL AND ON THE MACHINE

The following symbols are affixed inside the manual and on the machine that facilitate safe understanding of the steps involved.

	symbol applied on the machine	symbol in the manual
	not present	<p>DANGER: An imminent risk situation that, if not avoided, causes instantaneous death or serious or permanent damage to health.</p> <p>WARNING: A potential risk situation that, if not avoided, may cause death or serious damage to health.</p> <p>WARNING: A potential risk situation that, if not avoided, could cause minor damage</p>
	The symbol indicates that the surfaces marked by this symbol could be very hot or very cold and must therefore be touched carefully and using PPE (e.g. gloves)	The symbol indicates that operations marked with this symbol could cause thermal hazards (e.g. scalding or frostbite). The operations must therefore be carried out: <ul style="list-style-type: none"> - Carefully - Using PPE (e.g. gloves).
	If present, the symbols are positioned on refrigeration unit and indicate the flammability of the gas.	The symbol indicates that operations marked with this symbol could cause fires and/or explosions. The operations must therefore be carried out: Carefully <ul style="list-style-type: none"> - Using PPE (e.g. gloves).
 European market  North American market	<p>WARNING</p> <p>Do not use means to accelerate the defrosting process or to clean, other than those recommended by the manufacturer.</p> <p>The appliance shall be stored in a room without continuously operating ignition sources (for example: open flames, an operating gas appliance or an operating electric heater).</p> <p>Do not pierce or burn.</p> <p>Be aware that refrigerants may not contain an odour.</p>	
	<p>The symbol indicates that the guards marked with this symbol prevent contact with high-voltage parts.</p> <p>Do not remove or modify the guards marked with this symbol: electrocution hazard</p>	<p>The symbol indicates that operations marked with this symbol could cause electrical hazards (e.g. electrocution or electric shock).</p> <p>The operations must therefore be carried out:</p> <ul style="list-style-type: none"> - After disconnecting the power supply to the machine - Carefully - Using PPE (e.g. gloves).
	not present	The symbol indicates the need to read the manual carefully before installation, use and maintenance of the equipment.

SAFETY WARNINGS FOR INSTALLATION



FAILURE TO OBSERVE THE FOLLOWING RULES MAY RESULT IN DAMAGE AND INJURY, INCLUDING DEATH, AND MAY CAUSE THE WARRANTY TO BE INVALIDATED



DANGER The manufacturer cannot be held liable for any device use neglecting the indications provided in this manual. Remember that installation or maintenance other than those indicated in the manual can cause damages, injuries or fatal accidents.



DANGER Unauthorised actions, tampering or modifications that do not follow the information provided in this manual can cause damages, injuries or fatal accidents and null and void the warranty.



DANGER Read this manual carefully before device installation and maintenance and keep it for any further future consultation by the various operators.



DANGER Extraordinary installation and maintenance must be performed by skilled and authorised technicians, with good knowledge of the refrigerating and electrical plants, according to the legal provisions in force in the country of use and in compliance with the norms concerning the plants and the safety requirements at the workplace.



Attention! Risk of fire and flammable materials. If the equipment uses R290 coolant, every possible precaution must be taken to avoid any danger related to the flammability of this gas.



DANGER During installation, the use of PPE (personal protective equipment) is fundamental, the identification and choice of adequate personal protective equipment is the responsibility of the employer or the workplace manager or the technician in charge of technical service. The identified devices must be worn by the operators. During ordinary use, gloves protect your hands from the cold pan. Below is a list of the main personal protective equipment (PPE) to be used during the various work operations:

OPERATION	PROTECTIVE CLOTHING	SAFETY FOOTWEAR	GLOVES	GOGGLES	CRASH HELMET OR SAFETY HELMET
Transport and handling		■	□		□
Unpacking		■	□		
Assembly		■	□		
Extraordinary cleaning		■	■	□	
Maintenance		■	□		
Disassembly		■	□		
Scrapping		■	□		
■ Mandatory personal protective equipment (PPE). □ Personal protective equipment (PPE) to be used if necessary					



WARNING Make sure the mains voltage and the frequency correspond to those specified in the specifications plate before connecting the device to the electrical mains.



DANGER Disconnect the mains before any cleaning or maintenance (turn the main switch to OFF and remove the plug).



DANGER THE MACHINE WAS NOT DESIGNED TO BE INSTALLED IN AN ATMOSPHERE WITH RISK OF EXPLOSION. Do not store explosive substances, such as pressurised flammable propellant containers, inside the appliance.

- Before installation, please check:
 - that the areas in which the machine will be installed are suitable for food preparation;
 - that the plants comply with the legal provisions in force in the country of use and meet the specifications on the serial number plate;
 - that appropriate ground fault protection devices are already in place according to the electrical safety regulations in force in the country of installation and/or destination;
 - that a point of connection to the water mains is near the device;
 - that a socket with a ground connection of the country of use type is arranged near the device;
 - the planarity of the device support area, especially if it is assembled on wheels.

 **DANGER** During device installation:

- transit or permanence near the work area by individuals not assigned to device installation is prohibited;
- use the personal protection equipment (e.g. gloves, safety footwear, etc...);
- work according to workplace safety regulations (e.g. do not near electrical parts with wet hands or barefoot, etc...).

 **WARNING** ORIGINAL SPARE PARTS ARE RECOMMENDED. The manufacturer may not be held liable for the use of non original spare parts.

 **DANGER** Packaging material, since potentially hazardous, must be kept out of reach of children or animals and correctly disposed according to the local norms.

- The device is shipped after passing inspections: visual, electric and functional.

SAFETY WARNINGS FOR USE



FAILURE TO OBSERVE THE FOLLOWING RULES MAY RESULT IN DAMAGE AND INJURY, INCLUDING DEATH, AND MAY CAUSE THE WARRANTY TO BE INVALIDATED

 **DANGER** Any use and type of cleaning performed that is not in compliance with those specified and intended in this booklet is considered as incorrect and may cause damage, injuries or fatal accidents, will void the warranty and will exempt the manufacturer from any responsibility.

The appliance may be used by children aged 8 years and over, and by persons with reduced physical, sensory or mental capacity, or who lack experience or the necessary knowledge, provided that they are being supervised and have received instructions concerning safe use of the appliance and an understanding of the hazards involved.

 **DANGER** Children must not play with the appliance. Cleaning and maintenance to be carried out by the user must not be performed by children without supervision.





Caution! Risk of fire and flammable materials. If the equipment uses R290 refrigerant, every possible precaution must be taken in order to avoid any danger related to the flammability of this gas.







Caution! Danger of electrocution. Do not approach electrical components with wet hands or bare feet.

 **DANGER** It is strictly forbidden to tamper with or remove the safety devices employed (protective grilles, danger stickers, etc.). The manufacturer declines all responsibility if the afore-mentioned instructions are not respected.

 **WARNING** Do not insert screwdrivers or other tools between the protective devices (fan guards, evaporators, etc.). For the compressor and evaporator unit to function efficiently, never block the appropriate air intakes.

 **DANGER** While using the equipment, it is essential to use PPE (Personal Protective Equipment). The identification and selection of appropriate personal protective equipment is the responsibility of the employer or of the person in charge of the workplace. The PPE identified must be worn by the operators. During ordinary use, gloves protect the hands from the cold pan. Below is a list of the main personal protective equipment (PPE) to be used during the various work operations:

OPERATION	PROTECTIVE CLOTHING	SAFETY FOOTWEAR	GLOVES	GOGGLES	CRASH HELMET OR SAFETY HELMET
Ordinary use	■	■	□		
Routine cleaning		■	■	□	
■ Mandatory personal protective equipment (PPE) □ Personal protective equipment (PPE) to be used if necessary					

-  **WARNING** Keep clear of obstruction all ventilation openings in the appliance enclosure or in the structure for building-in.
-  **WARNING** Do not use mechanical devices or other means to accelerate the defrosting process, other than those recommended by the manufacturer.
-  **WARNING** Do not damage the refrigerant circuit.
-  **WARNING** Do not use electrical appliances inside the food storage compartments of the appliance, unless they are of the type recommended by the manufacturer.

CORRECT USE OF THE EQUIPMENT

- This equipment is considered an agri-food machine (EC Regulation no. 1935/2004), intended to process food products in industrial and professional kitchens. It is not suited to store pharmaceutical, chemical or any other non-food product.
- Before starting and using the appliance, carefully wash its internal surfaces.
- In order to achieve the best performance from the equipment, it is necessary to observe the following instructions:
 - Do not place hot foods or uncovered liquids, live animals, miscellaneous objects or corrosive products inside the equipment
 - Wrap or otherwise protect food, particularly if it contains herbs or spices
 - Arrange the food items inside the equipment without impeding the air circulation and do not place paper, cardboard, chopping boards, etc. over the grilles, which could obstruct the air flow
 - Avoid frequent and prolonged door openings as much as possible
 - If the door has been opened and then reclosed, wait a few moments before reopening it
 - Maximum load pan or grille: 20kg | 44.1 lbs (GN 1/1) or 35 kg | 77.2 lbs (GN 2/1).
- The refrigeration equipment has been manufactured and designed with the appropriate precautions to ensure the health and safety of the user and does not present dangerous edges, sharp surfaces or elements protruding from the overall dimensions.

 **WARNING** The equipment is guaranteed to be stable even with the doors open; **it is, however, strictly forbidden to hang from the door(s).**

- For cells with an on-board motor, ensure the appliance is secured to the floor using the brackets supplied, to prevent it from accidentally tipping over. For information on how to fix the appliance, see figure 5.

INCORRECT USE OF THE EQUIPMENT THAT COULD REASONABLY BE PREDICTED

 **DANGER** Any use other than those specified in this manual is incorrect. Incorrect use can lead to serious risks for the safety of users and damage to the equipment.

The following are considered reasonably predictable incorrect uses:

- Lack of maintenance, cleaning and routine checks on the equipment
- Structural modifications or changes to the operating logic
- Mishandling of protective covers or safety devices

- Non-use of PPE by operators, specialist staff and maintenance technicians
- Use of inappropriate accessories (e.g. use of unsuitable equipment, ladders)
- Storage, in the vicinity of the equipment, of combustible or flammable materials not compatible with or not relevant to production
- Incorrect installation of the equipment
- Putting into the equipment items and materials incompatible with its use or that might damage the equipment itself, harm people or pollute the atmosphere
- Climbing onto the equipment or hanging from the doors
- Non-observance of the instructions given about the intended use of the equipment
- Leaving doors or drawers open or partly open, through forgetfulness or carelessness
- Positioning the product in spaces in such a way as to stop air circulating correctly or prevent doors/drawers closing properly
- Exceeding the weight of product allowed for each shelf/drawer.

RISKS ASSOCIATED WITH THE USE OF THE EQUIPMENT

 **CAUTION** RISKS DUE TO MOVING IT ON WHEELS: if the equipment is fitted with wheels, be careful not to push it too forcefully whilst moving it, to avoid it tipping over and being damaged. Also take care with any unevenness of the surface it's moving across. Equipment that is on wheels has no levelling mechanism, so make sure that the supporting surface is perfectly horizontal and flat. Always lock the wheels with the devices provided.

 **CAUTION** RISKS DUE TO MOVABLE ELEMENTS: the only movable element is the fan, but it presents no risk because it is covered by a protective grille fastened with screws.



RISKS DUE TO HIGH/LOW TEMPERATURES: stickers saying "DANGER - TEMPERATURE" have been displayed in areas where there is the danger of high/low temperatures.



RISKS DUE TO ELECTRICITY: risks of an electrical nature have been solved by designing the electrical systems according to standard CEI EN 60335-1. Appropriate warning labels indicating "high voltage" identify the zones with dangers of an electrical nature.

- Noise levels below 70 dB.

 **DANGER** Do not open more than one drawer or more than one shelf at the same time, in order to avoid the possibility of it tipping over.

INSTRUCTION FOR ETL AND FLAMABLE EQUIPMENTS

- The new hose-sets supplied with the appliance are to be used and old hose-sets should not be reused.
- Component parts shall be replaced with like components so as to minimize the risk of possible ignition due to incorrect parts.

WARNING! Use only spare parts which are indicated on exploded drawings. Contact the Manufacturer.

- The appliance is to be installed in accordance with the Safety Standard for Refrigeration Systems, ANSI/ASHRAE 15.
- The appliance shall not be installed in public corridors or lobbies.

Qualification of workers

Every working procedure that affects safety means shall only be carried out by trained, recognized and licensed personnel for the task. Examples for such working procedures are:

- a) breaking into the refrigerating circuit;
- b) opening of sealed components;
- c) opening of ventilated enclosures.

Beginning work

- Prior to beginning work on systems containing FLAMMABLE REFRIGERANTS, safety checks are necessary to ensure that the risk of ignition is minimised. For repair to the REFRIGERATING SYSTEM, point from A) to point E) shall be completed prior to conducting work on the system.

A) Work procedure

- Work shall be undertaken under a controlled procedure so as to minimise the risk of a flammable gas or vapour being present while the work is being performed.

B) General work area

- All maintenance staff and others working in the local area shall be instructed on the nature of work being carried out. Work in confined spaces shall be avoided.

C) Checking for presence of refrigerant

- The area shall be checked with an appropriate refrigerant detector prior to and during work, to ensure the technician is aware of potentially toxic or flammable atmospheres. Ensure that the leak detection equipment being used is suitable for use with all applicable refrigerants, i.e., non-sparking, adequately sealed, or intrinsically safe.

D) Presence of fire extinguisher

- If any hot work is to be conducted on the refrigerating equipment or any associated parts, appropriate fire extinguishing equipment shall be available on hand. A dry chemical or CO2 fire extinguisher should be adjacent to the charging area.

E) No ignition sources

- No person carrying out work in relation to a REFRIGERATING SYSTEM which involves exposing any pipe work shall use any sources of ignition in such a manner that it may lead to the risk of fire or explosion. All possible ignition sources, including cigarette smoking, should be kept sufficiently far away from the site of installation, repairing, removing and disposal, during which refrigerant can possibly be released to the surrounding space. Prior to work taking place, the area around the equipment shall be surveyed to make sure that there are no flammable hazards or ignition risks. "No Smoking" signs shall be displayed.

Ventilated area

- Ensure that the area is in the open or that it is adequately ventilated before breaking into the system or conducting any hot work. A degree of ventilation shall continue during the period that the work is carried out. The ventilation should safely disperse any released refrigerant and preferably expel it externally into the atmosphere.

Checks to the refrigerating equipment

- Where electrical components are being changed, they shall be fit for the purpose and to the correct specification. At all times, the manufacturer's maintenance and service guidelines shall be followed. If in doubt, consult the manufacturer's technical department for assistance.
- The following checks shall be applied to installations using FLAMMABLE REFRIGERANTS:
 - a) the actual REFRIGERANT CHARGE is in accordance with the room size within which the refrigerant containing parts are installed;

- b) the ventilation machinery and outlets are operating adequately and are not obstructed;
- c) if an indirect refrigerating circuit is being used, the secondary circuit shall be checked for the presence of refrigerant;
- d) marking to the equipment continues to be visible and legible. Markings and signs that are illegible shall be corrected;
- e) refrigerating pipe or components are installed in a position where they are unlikely to be exposed to any substance which may corrode refrigerant containing components, unless the components are constructed of materials which are inherently resistant to being corroded or are suitably protected against being so corroded.

Repair and maintenance

Repair and maintenance to electrical components shall include initial safety checks and component inspection procedures. If a fault exists that could compromise safety, then no electrical supply shall be connected to the circuit until it is satisfactorily dealt with. If the fault cannot be corrected immediately but it is necessary to continue operation, an adequate temporary solution shall be used. This shall be reported to the owner of the equipment, so all parties are advised. Initial safety checks shall include:

- a) that capacitors are discharged: this shall be done in a safe manner to avoid possibility of sparking;
- b) that no live electrical components and wiring are exposed while charging, recovering or purging the system;
- c) that there is continuity of earth bonding.

Repair sealed components

- During repairs to sealed components, all electrical supplies shall be disconnected from the equipment being worked upon prior to any removal of sealed covers, etc. If it is absolutely necessary to have an electrical supply to equipment during servicing, then a permanently operating form of leak detection shall be located at the most critical point to warn of a potentially hazardous situation.

Work on electrical components

- Particular attention shall be paid to the following to ensure that by working on electrical components, the casing is not altered in such a way that the level of protection is affected. This shall include damage to cables, excessive number of connections, terminals not made to original specification, damage to seals, incorrect fitting of glands, etc.
- Ensure that apparatus is mounted securely.
- Ensure that seals or sealing materials have not degraded to the point that they no longer serve the purpose of preventing the ingress of flammable atmospheres. Replacement parts shall be in accordance with the manufacturer's specifications.

Repair to intrinsically safe components

- Do not apply any permanent inductive or capacitance loads to the circuit without ensuring that this will not exceed the permissible voltage and current permitted for the equipment in use.
- Intrinsically safe components are the only types that can be worked on while live in the presence of a flammable atmosphere. The test apparatus shall be at the correct rating.
- Replace components only with parts specified by the manufacturer. Other parts can result in the ignition of refrigerant in the atmosphere from a leak. NOTE The use of silicon sealant can inhibit the effectiveness of some types of leak detection equipment.
- Intrinsically safe components do not have to be isolated prior to working on them.

Cabling

- Check that cabling will not be subject to wear, corrosion, excessive pressure, vibration, sharp edges, or any other adverse environmental effects. The check shall also take into account the effects of aging or continual vibration from sources such as compressors or fans.

Detection of flammable refrigerants

- Under no circumstances shall potential sources of ignition be used in the searching for or detection of refrigerant leaks. A halide torch (or any other detector using a naked flame) shall not be used.
- The following leak detection methods are deemed acceptable for all refrigerant systems.
- Electronic leak detectors may be used to detect refrigerant leaks but, in the case of FLAMMABLE REFRIGERANTS, the sensitivity might not be adequate, or might need recalibration. (Detection equipment shall be calibrated in a refrigerant-free area.) Ensure that the detector is not a potential source of ignition and is suitable for the refrigerant used. Leak detection equipment shall be set at a percentage of the LFL of the refrigerant and shall be calibrated to the refrigerant employed, and the appropriate percentage of gas (25 % maximum) is confirmed.
- Leak detection fluids are also suitable for use with most refrigerants but the use of detergents containing chlorine shall be avoided as the chlorine can react with the refrigerant and corrode the copper pipe-work.

NOTE Examples of leak detection fluids are:

- bubble method,
- fluorescent method agents.
- If a leak is suspected, all naked flames shall be removed/extinguished.
- If a leakage of refrigerant is found which requires brazing, all of the refrigerant shall be recovered from the system, or isolated (by means of shut off valves) in a part of the system remote from the leak. Removal of refrigerant shall be according to chapter below **“Removal and evacuation”**.

Removal and evacuation

- When breaking into the refrigerant circuit to make repairs — or for any other purpose — conventional procedures shall be used. However, for flammable refrigerants it is important that best practice be followed, since flammability is a consideration. The following procedure shall be adhered to:
 - a) safely remove refrigerant following local and national regulations;
 - b) purge the circuit with inert gas;
 - c) evacuate;
 - d) purge with inert gas;
 - e) open the circuit by cutting or brazing.
- The refrigerant charge shall be recovered into the correct recovery cylinders if venting is not allowed by local and national codes. For appliances containing flammable refrigerants, the system shall be purged with oxygen-free nitrogen to render the appliance safe for flammable refrigerants. This process might need to be repeated several times.
- Compressed air or oxygen shall not be used for purging refrigerant systems.
- For appliances containing flammable refrigerants, refrigerants purging shall be achieved by breaking the vacuum in the system with oxygen-free nitrogen and continuing to fill until the working pressure is achieved, then venting to atmosphere, and finally pulling down to a vacuum. This process shall be repeated until no refrigerant is within the system.
- When the final oxygen-free nitrogen charge is used, the system shall be vented down to atmospheric pressure to enable work to take place.
- Ensure that the outlet for the vacuum pump is not close to any potential ignition sources and that ventilation is available.

Charging procedures

- In addition to conventional charging procedures, the following requirements shall be followed.
 - a) Ensure that contamination of different refrigerants does not occur when using charging equipment. Hoses or lines shall be as short as possible to minimise the amount of refrigerant contained in them.
 - b) Cylinders shall be kept in an appropriate position according to the instructions.
 - c) Ensure that the REFRIGERATING SYSTEM is earthed prior to charging the system with refrigerant.
 - d) Label the system when charging is complete (if not already).
 - e) Extreme care shall be taken not to overfill the REFRIGERATING SYSTEM.
- Prior to recharging the system, it shall be pressure-tested with the appropriate purging gas. The system shall be leak-tested on completion of charging but prior to commissioning. A follow up leak test shall be carried out prior to leaving the site.

Decommissioning

- Before carrying out this procedure, it is essential that the technician is completely familiar with the equipment and all its detail. It is recommended good practice that all refrigerants are recovered safely. Prior to the task being carried out, an oil and refrigerant sample shall be taken in case analysis is required prior to re-use of recovered refrigerant. It is essential that electrical power is available before the task is commenced.
 - a) Become familiar with the equipment and its operation.
 - b) Isolate the system electrically.
 - c) Before attempting the procedure, ensure that:
 - i) mechanical handling equipment is available, if required, for handling refrigerant cylinders;
 - ii) all personal protective equipment is available and being used correctly;
 - iii) the recovery process is supervised at all times by a competent person;
 - iv) recovery equipment and cylinders conform to the appropriate standards.
 - d) Pump down refrigerant system, if possible.
 - e) If a vacuum is not possible, make a manifold so that refrigerant can be removed from various parts of the system.
 - f) Make sure that cylinder is situated on the scales before recovery takes place.
 - g) Start the recovery machine and operate in accordance with instructions.
 - h) Do not overfill cylinders (no more than 80 % volume liquid charge).
 - i) Do not exceed the maximum working pressure of the cylinder, even temporarily.
 - j) When the cylinders have been filled correctly and the process completed, make sure that the cylinders and the equipment are removed from site promptly and all isolation valves on the equipment are closed off.
 - k) Recovered refrigerant shall not be charged into another REFRIGERATING SYSTEM unless it has been cleaned and checked.

Labelling

Equipment shall be labelled stating that it has been de-commissioned and emptied of refrigerant. The label shall be dated and signed. For appliances containing FLAMMABLE REFRIGERANTS, ensure that there are labels on the equipment stating the equipment contains FLAMMABLE REFRIGERANT.

Removing refrigerant operations

When removing refrigerant from a system, either for servicing or decommissioning, it is recommended good practice that all refrigerants are removed safely. When transferring refrigerant into cylinders, ensure that only appropriate refrigerant recovery cylinders are employed. Ensure that the correct number of cylinders for holding the total system charge is available. All cylinders to be used are designated for the recovered refrigerant and labelled for that refrigerant (i.e., special

cylinders for the recovery of refrigerant). Cylinders shall be complete with pressure-relief valve and associated shut-off valves in good working order. Empty recovery cylinders are evacuated and, if possible, cooled before recovery occurs. The recovery equipment shall be in good working order with a set of instructions concerning the equipment that is at hand and shall be suitable for the recovery of all appropriate refrigerants including, when applicable, FLAMMABLE REFRIGERANTS. In addition, a set of calibrated weighing scales shall be available and in good working order. Hoses shall be complete with leak-free disconnect couplings and in good condition. Before using the recovery machine, check that it is in satisfactory working order, has been properly maintained and that any associated electrical components are sealed to prevent ignition in the event of a refrigerant release. Consult manufacturer if in doubt. The recovered refrigerant shall be returned to the refrigerant supplier in the correct recovery cylinder, and the relevant waste transfer note arranged. Do not mix refrigerants in recovery units and especially not in cylinders. If compressors or compressor oils are to be removed, ensure that they have been evacuated to an acceptable level to make certain that FLAMMABLE REFRIGERANT does not remain within the lubricant. The evacuation process shall be carried out prior to returning the compressor to the suppliers. Only electric heating to the compressor body shall be employed to accelerate this process. When oil is drained from a system, it shall be carried out safely.

RESIDUAL RISKS

- The correct design of the equipment and the installation of adequate protective devices do not completely eliminate the risks for the operator. This manual contains the list of personal protective equipment (PPE) that the employee must use. Sufficient space is provided during the installation phases of the equipment to limit the risks. To maintain these conditions, the areas surrounding the equipment must be kept clean, dry, well-lit and free from obstacles. Below is a list of the residual risks that remain on the machine.

RESIDUAL RISK	DESCRIPTION
Slipping or falling	The operator can slip due to the presence of water, oil or dirt on the floor.
Burns or abrasion	The user intentionally or unintentionally touches some of the components inside the equipment (e.g. cold trays, fins and cooling circuit tubes) without using protective gloves.
Electrocution	Contact with live electrical parts during maintenance operations carried out without disconnecting the power supply
Falling	The operator intervenes on the equipment using unsuitable systems to access the upper part.
Injuries	Specialist personnel may not properly secure the upper control console. The latter could detach and fall off.
Overturning	While moving the equipment and packaging using lifting and/or handling systems that are unsuitable or with the load unbalanced
Refrigerant gas	Inhalation of refrigerant gas. The type of refrigerant is shown on the equipment technical specifications plate

EMERGENCY SITUATIONS

 **CAUTION** In the event of fire, do not use water, keep CO₂ (carbon dioxide) extinguishers to hand and cool the motor compartment as quickly as possible.

IN CASE OF EQUIPMENT MALFUNCTIONING...

 **CAUTION** If the equipment does not work or you notice functional or structural changes, disconnect it from all the mains supplies and contact a service centre authorised by the manufacturer, without attempting to repair it yourself.

 **CAUTION** Be sure to use original spare parts. The manufacturer declines any responsibility for the use of non-original spare parts.

- To ensure that the equipment is maintained in perfect conditions for use and safety, we recommend that a service and inspection be carried out by an authorised service centre at least once a year.

R290 REFRIGERANT GAS WARNINGS

The volume of the room where the equipment is located must be greater than one cubic meter to allow dispersion of the gas.

GAS CHARACTERISTICS

R290
propane chemical formula: C ₃ H ₈
Global warming potential (GWP) = 3.
Ozone destruction potential (ODP) = 0.
Safety classification: A3. Non-toxic but extremely flammable.
The substance is regulated by the Montreal Protocol (1992 revision).

HAZARD IDENTIFICATION

R290
Do not smoke or inhale. The gas is highly flammable . Keep it away from heat sources, hot surfaces, sparks, naked flames or other ignition sources.



Low concentrations can cause narcotic effects with possible loss of consciousness, dizziness, headaches, nausea and loss of coordination.

High concentrations can cause asphyxiation due to reduced oxygen content in the atmosphere.

Very high concentrations can cause abnormalities of the heart rhythm and sudden death.

The sprayed or splashed product may cause skin burns and serious eye damage. It is unlikely to be dangerous by skin absorption. Repeated or prolonged contact can cause the removal of skin fat, resulting in dryness, chapping and dermatitis.

Do not smoke or inhale.

FIRST AID MEASURES



If the person is unconscious, place them on their side in a stable position and consult a doctor. Do not give anything to unconscious persons. In case of irregular breathing or respiratory arrest, practice artificial respiration. In case of persistence of the disorders or symptoms consult a doctor.

Inhalation: remove the injured person from exposure by wearing the breathing apparatus, take them to a warm place and keep them lying down. If necessary, practice artificial respiration, administer oxygen or perform cardiac massage. Seek immediate medical attention.

Skin contact: defrost the affected areas with water. Remove contaminated clothing, as it may adhere to the skin in case of frostbite. Immediately and abundantly wash the affected areas with warm water. If skin irritation or blistering occurs, seek medical attention.

Eye contact: check if the injured person is wearing contact lenses. If this is the case, remove them, wash the eyes immediately with clean water, keeping the eyelids blinking, for at least 15 minutes. Do not apply ointments or oil. Seek medical attention.



Ingestion: do not induce vomiting! If the injured person is conscious, rinse the mouth with water and drink 200-300 ml of water. Seek immediate medical attention.

Additional medical care: symptomatic treatment and supportive care when indicated. Do not administer adrenaline and similar sympathomimetic drugs following exposure due to the risk of cardiac arrhythmia with possible cardiac arrest.

FIRE-FIGHTING MEASURES

R290 HIGHLY FLAMMABLE GAS	
	Keep unprotected persons away and evacuate them to safe areas.
	To extinguish any fire, always use a self-contained respirator and appropriate protective clothing (e.g. protective gloves or goggles).
	Incomplete thermal decomposition causes the emission of very toxic and corrosive vapours (carbon monoxide). Cool the motor compartment area as quickly as possible. An explosive re-ignition may occur. Extinguish all surrounding flames. Move any combustible objects away from the fire area <u>if this can be performed safely</u> .
What to use to extinguish the fire: alcohol-resistant foam, dust and CO ₂ carbon dioxide, water spray to reduce or remove the fumes.	
What NOT to use to extinguish the fire: strong jets of water	

ACCIDENTAL SPILLS

R290	
	Keep unprotected persons away and evacuate them to safe areas. Immediately ventilate the area following the local safety plan. Do not touch or inhale the leaked gas.
	Disconnect the power cord of the equipment from which the gas is escaping.
	For the management of spills, wear suitable respiratory protection devices with air reserve, gloves and protective goggles. Avoid the inhalation of vapours. Atmospheric concentrations must be kept to a minimum and kept to the minimum reasonably possible level, below the occupational exposure limit. Vapours are heavier than air and therefore high concentrations could form near the ground where general ventilation is poor. Avoid contact with naked flames and hot surfaces because irritating and toxic decomposition products may form or, in the case of flammable gases (R290), explosions and fires. Disposal of the leaked gas must be carried out by authorised and qualified centres. If in doubt, contact the local authorities for additional information. When the emergency is over, contact the technical assistance for repair of the machine.

R290	
<p><u>Minor leaks:</u> do not attempt to stop the gas leak.</p> <p><u>Leaks of significant magnitude:</u> contain spilled material with sand, soil or other suitable absorbent material. Prevent liquid from entering drains, sewers, basements and working holes because the vapours can create a suffocating atmosphere.</p> <p>Consider that R290 gas is highly flammable.</p>	<p><u>Minor leaks:</u> if the conditions are sufficiently safe and there is adequate ventilation, isolate the source of the leak and allow the material to evaporate safely.</p> <p><u>Leaks of significant magnitude:</u> contain spilled material with sand, soil or other suitable absorbent material. Prevent liquid from entering drains, sewers, basements and working holes because the vapours can create a suffocating atmosphere.</p>

DISPOSAL

It is strictly forbidden to discharge this refrigerant into the atmosphere which must be properly recovered, treated or disposed of following the legal procedures, using qualified and enabled personnel. If in doubt, contact the local authorities for additional information. The best solution is to recover and recycle the product: if this is not possible, destruction must take place at an authorised plant equipped to absorb and neutralise acid gases and other toxic processing products.

SERVICE AND REPAIRS

If the equipment does not work or functional or structural alterations are noted:

- disconnect it from the power and water mains
- contact a manufacturer's authorized service center communicating the nature of the defect, along with the equipment code and serial number found on its specification plate

Original spare parts are required for repairs. The manufacturer cannot be held liable and the warranty will be null and void in the event that non original spare parts are used.

To ensure that the appliance is in perfect use and safety conditions, we recommend you have it maintained and serviced by an authorized service center at least once a year.

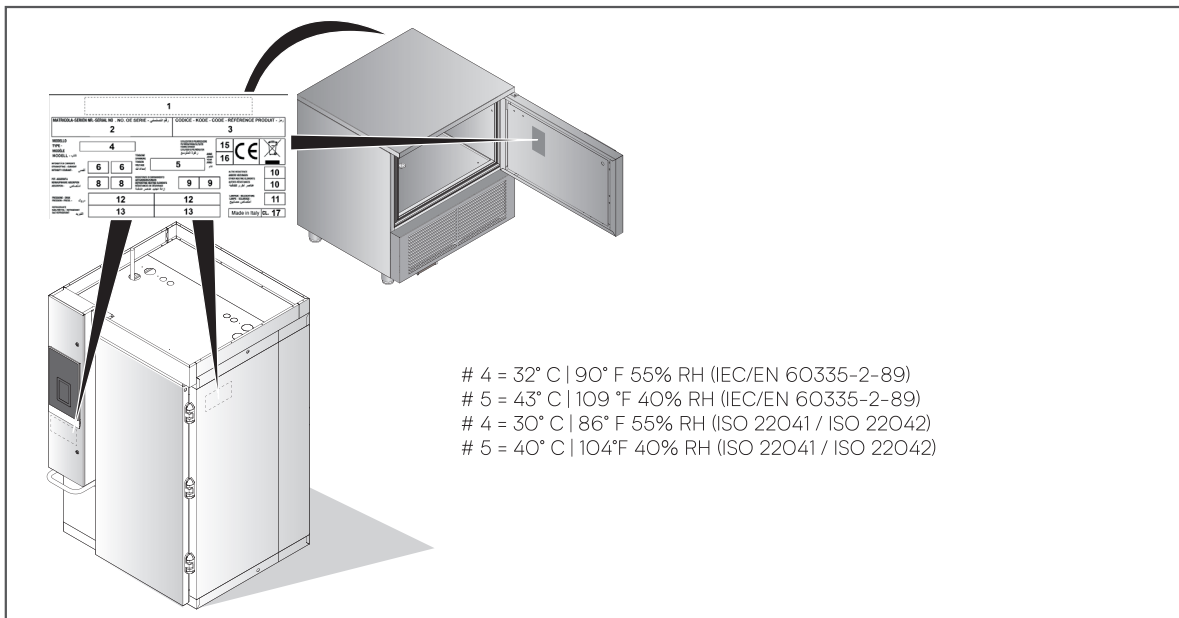

- | | |
|--------------------------------------|-------------------------------------|
| 1 Manufacturer | 10 Rated power of other resistances |
| 2 Serial number | 11 Lamp power |
| 3 Code | 12 Maximum and minimum pressure |
| 4 Model | 13 Coolant, type and quantity |
| 5 Voltage | 15 Gas expanding in the insulation |
| 6 Current absorbed during operation | 16 Year of manufacture |
| 8 Power of the defrosting resistance | 17 Climate class (#) |
| 9 Power of the defrosting resistance | |

FOR THE SERVICE TECH - TECHNICAL DATA

R290 MOD. "S" R290
 ISO 22042
 +65°C > +10°C | +149°F > + 50°F
 +65°C > -18°C | +149°F > 0°F

MOD. "R" R290
 ISO 22042
 +65°C > +10°C | +149°F > + 50°F
 +65°C > -18°C | +149°F > 0°F

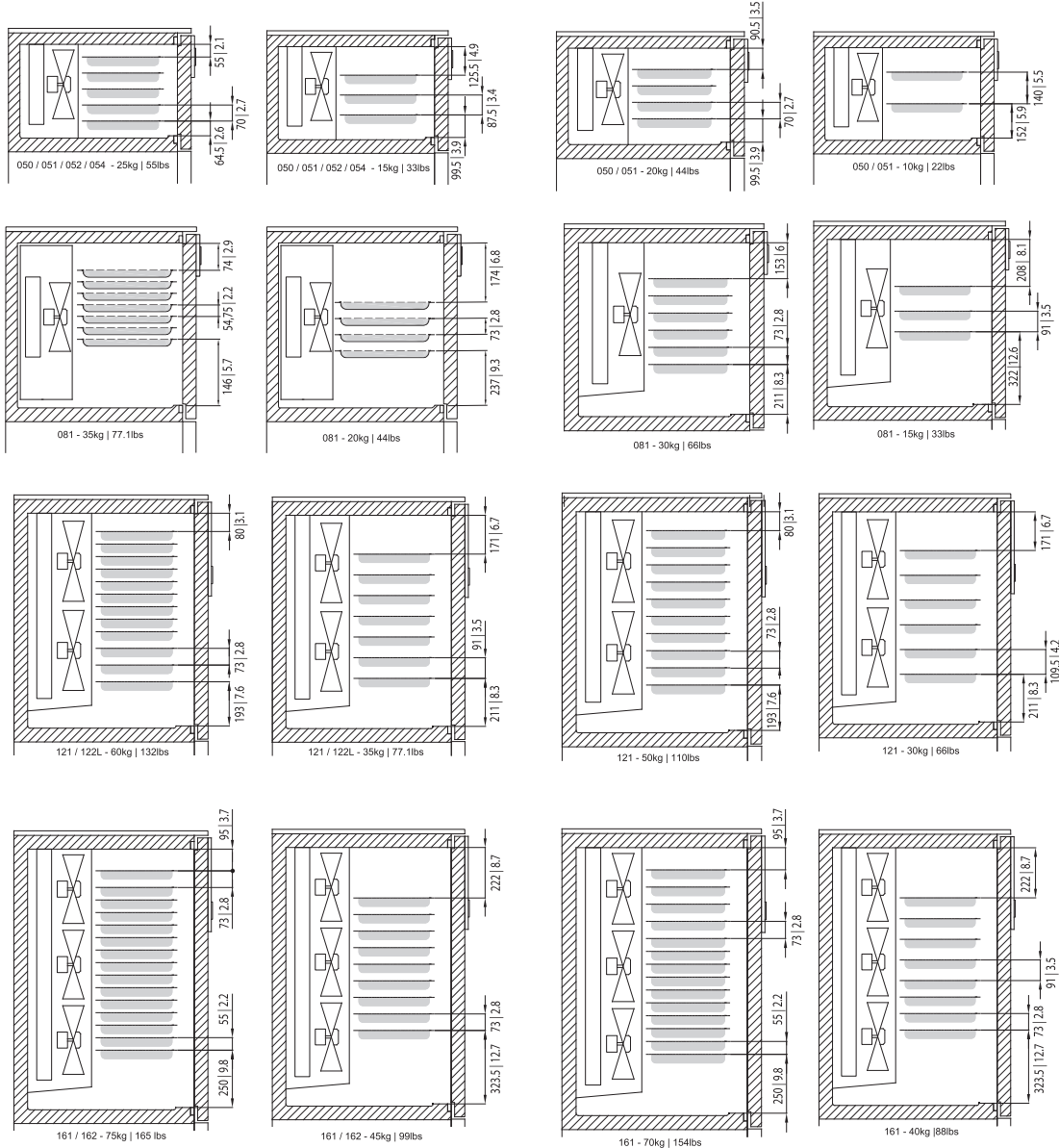

[mm | in]

Model	Power Supply	Version	Gas Quantity	Yield Per Cycle		According to Standard ISO 22042			
						Yield Per Cycle		Consumption for Cycle	
				BC +90/+3 °C +194/+37 °F	BF +90/-18 °C +194/0 °F	BC +65/+10 °C +149°F/+50°F	BF 65°C/-18°C +149°F/0°F	BC	BF
				[kg lbs]	[kg lbs]	[kg lbs]	[kg lbs]	[kW]	[kW]
RBS-054-SA-HC	208-230/1N~/60	A	150 5.3	30 66.14	20 44.09	25 55.12	15 33.07	1.72	3.29
RBS-122L-SA-HC	208-230/3~/60	A	2 x 150 5.3	65 143.3	45 99.21	60 132.28	35 77.16	4,36	8,13
RBS-162-SA-HC	208-230/3~/60	A	2 x 150 5.3	80 176.37	55 121.25	75 165.35	45 99.21	5,74	11,09

Model	Electric Power	Electric Absorption	Gas Type	Net Weight	Gross Weight	Width	Depth	Height	Number of Trays
	[W]	[A]		[kg lbs]	[kg lbs]	[mm inch]	[mm inch]	[mm inch]	
RBS-054-SA-HC	1450	8,68	R290	125 275.58	165 363.76	850 33.46	880 34.65	970 38.19	5 x (26X18") 5 x GN 1/1 5 x EN1
RBS-122L-SA-HC	3629	12,6	R290	230 507.05	275 606.27	850 33.46	1000 39.37	1810 71.25	12 x GN 2/1 24 x GN 1/1
RBS-162-SA-HC	3340	11,6	R290	255 562.17	300 661.39	850 33.46	1000 39.37	1960 77.16	16 x GN 2/1 32 x GN 1/1

FOR THE SERVICE TECH WIRING DIAGRAMS - RBS-052-SA-HC & RBS-054-SA-HC

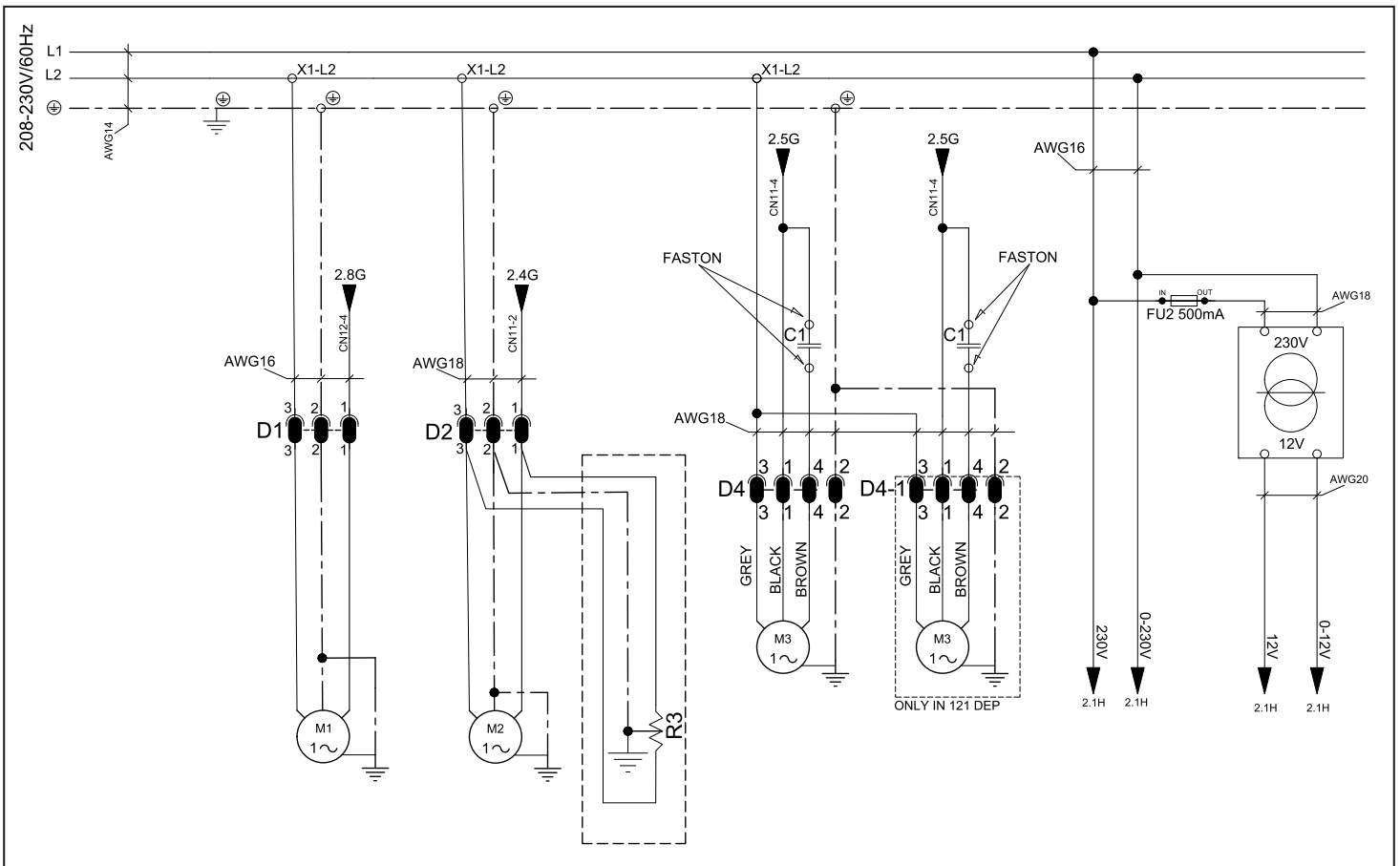

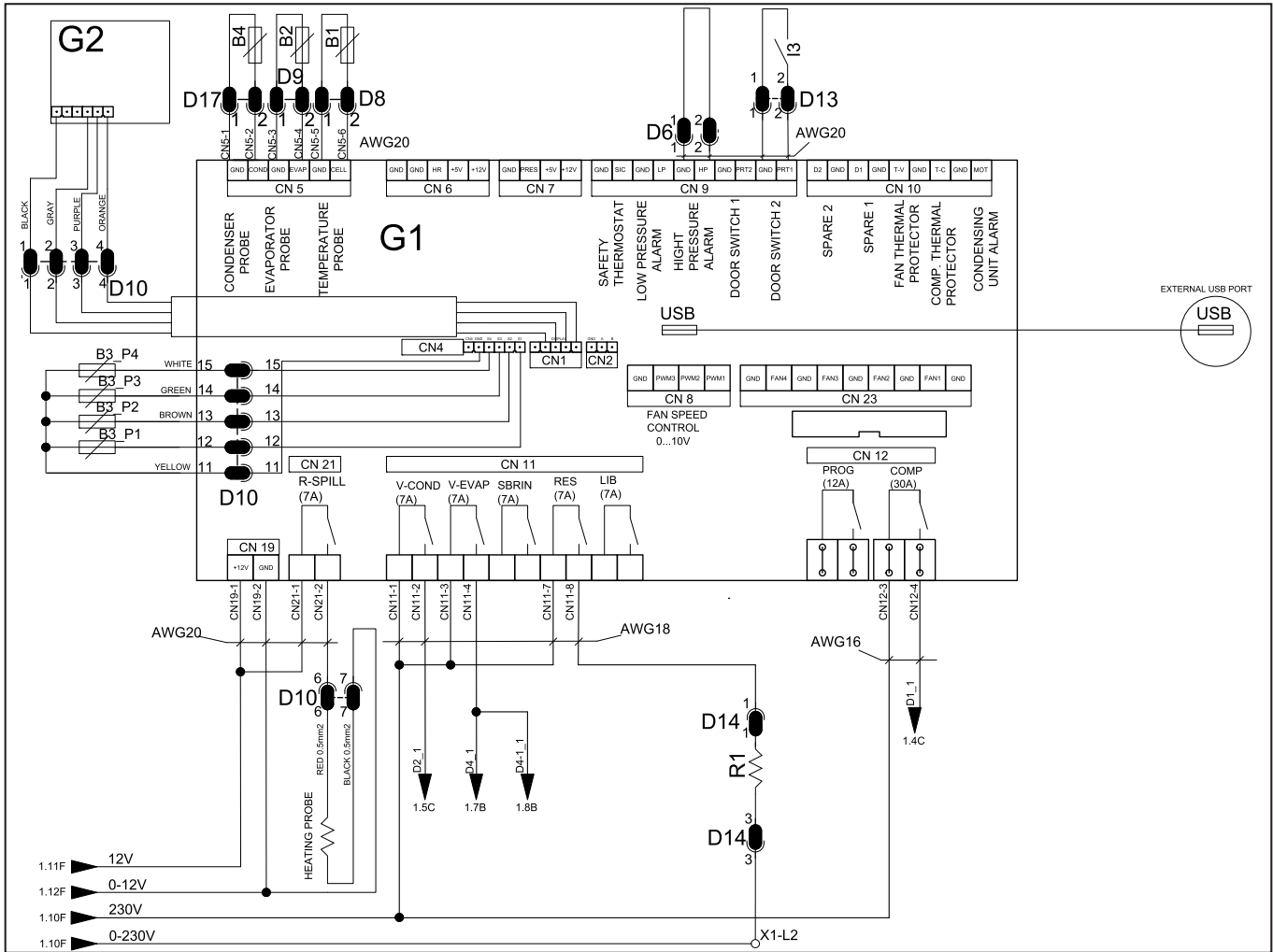

LAYOUT

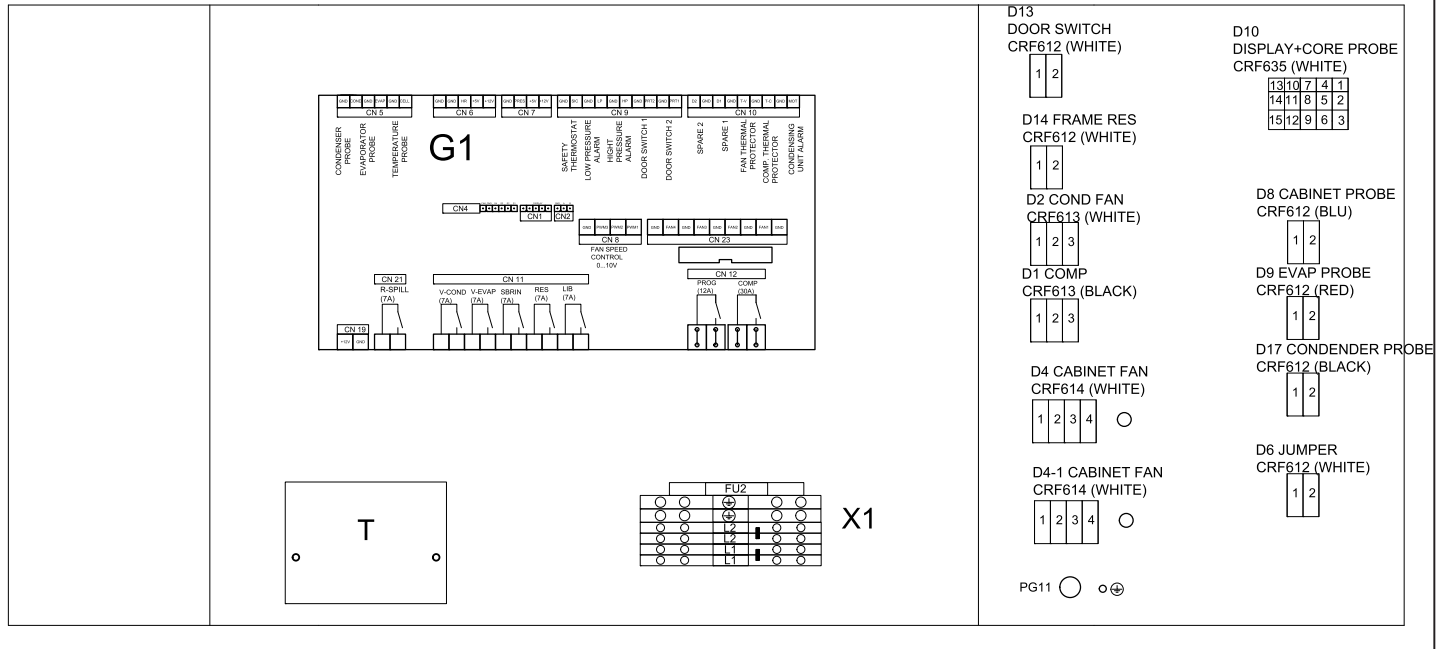

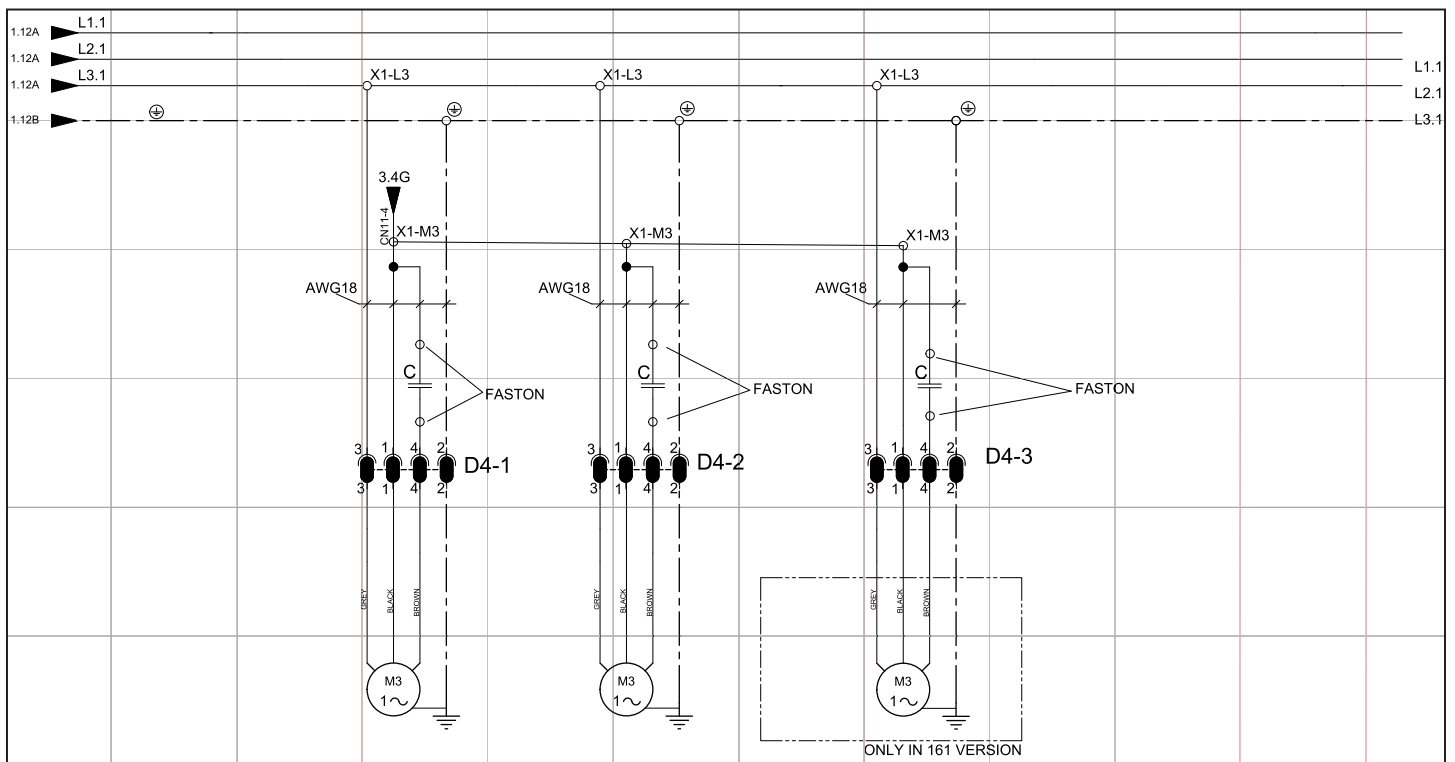

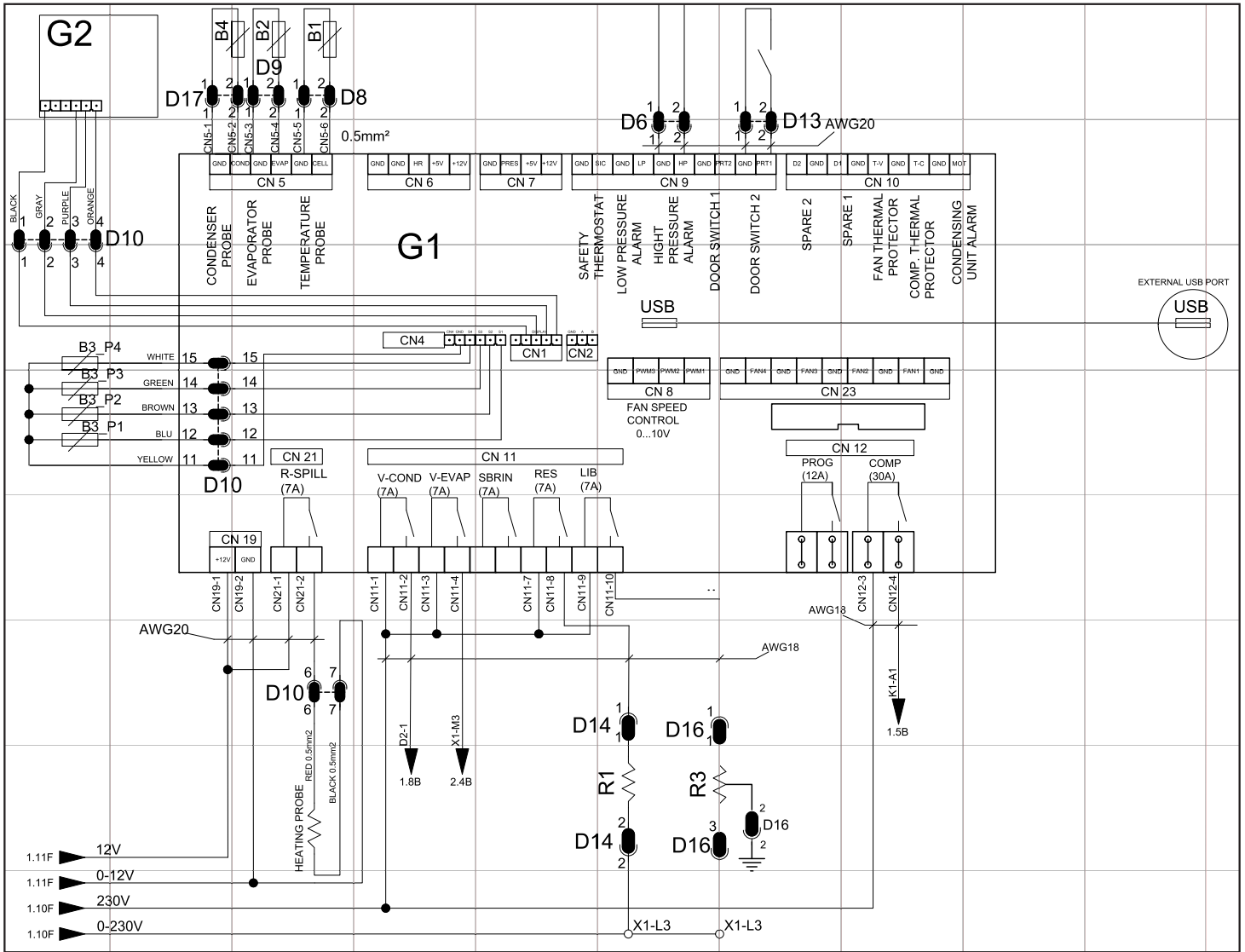

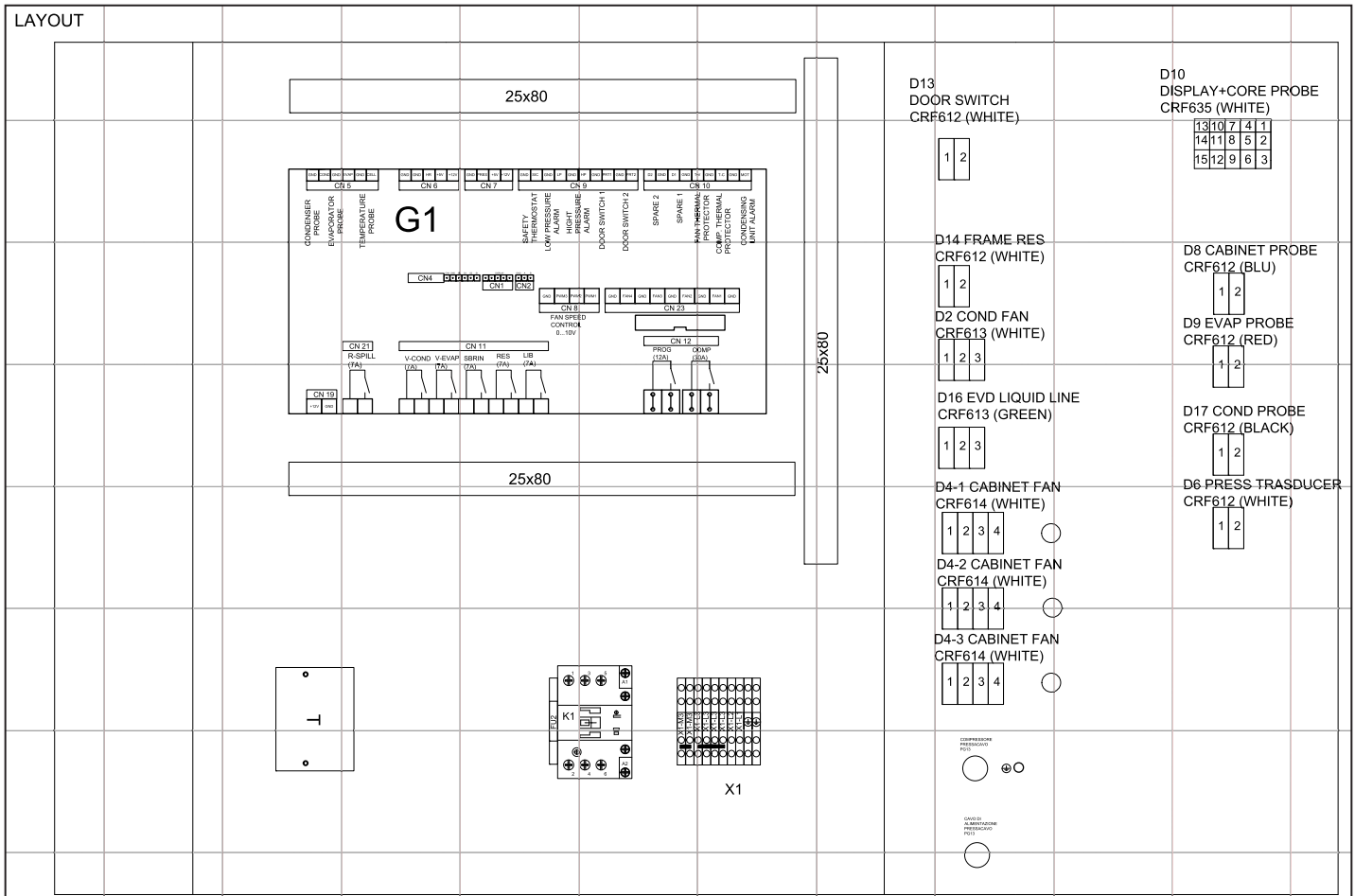

FOR THE SERVICE TECH WIRING DIAGRAMS GENERAL LEGEND

A	Power supply unit
A1	Lamp power supply unit
A2	Printer power supply unit
B	Probe
B1	Temperature probe
B2	Defrosting probe
B3	Core probe
B4	Condenser probe
B5	Vacuum probe
B6	Humidity probe
B7	Evaporator outlet temperature probe
B8	Surface probe
BX	Sanitizing
C	Electric condenser
CK	Buzzer
D	Voltage variator
D1...16	Quick connector
E	Thermostat
E1	Safety thermostat
E2	Control thermostat
EEV	Electronic expansion valves
EVD	EEV control module
FU	Fuse
G	Thermostat
G1	Power card
G2	Command card
G3	Auxiliary card
G4	Printer + IF RICS
G5	Fan control
G6	Encoder
H	Indicator light
H1	Power indicator light
H2	Alarm indicator light
H3	Defrosting indicator light
H4	Cycle indicator light
IG	Main switch
I1	Switch
I2	Switch
I3	Door microswitch
I4	Float
I5	Selector
I6	Evaporator micro switch
K1	Compressor contactor
K2	Condenser contactor
K3	Evaporator fan contactor
K4	UVC contactor
K5	Defrosting contactor
K6	Delayed contact
K8	Room heating contactor
KA	Auxiliary relay
L	Line
L1	3-phase line #1
L2	3-phase line #2
L3	3-phase line #3
M	Electric motor
M1	Compressor
M2	Condenser fan
M3	Evaporator fan
M4	Additional motorised fan
M5	Linear actuator
M6	Heating and dehumidification fan

N	Neutral
O	Timer
P	Pressure switch
PE	Earth point
P1	Pressure transducer
P2	Pressure transducer
Q	Relay
Q1	Power relay
Q2	Relay with 2 contacts
Q3	Thermal protection relay for compressor
Q4	Water supply relay
Q5	Detergent supply relay
Q6	Detergent pump relay
Q7	Drain valve relay
Q8	Heating relay
Q9	Drain safety relay
QS	Main switch
R	Resistance
R1	Frames resistance
R2	Defrosting resistance
R3	Evaporation resistance
R4	Heating resistance
R5	Guard resistance
R6	Discharge resistance
R7	Pressure balancing valve resistance
R8	Frame heating glass doors (on the glass)
R9	Perimetrical heater for glass doors
R10	Humidify heating element
S	Starter
T	Transformer
T1	Automatic transformer
T2	Ballast
TX	Transformer for sanitizing
TB	Thermal breaker
U	Thermometer
V1	Solenoid-valve
V2	Water solenoid-valve
V3	Solenoid-valve warm gas
V4	By-pass valve
W	Lamp
W1	Neon lamp
W2	UVC lamp
X	Terminal
X1	Terminal board
XM	Evaporator module terminal block
Y1	Compressor thermal-breaker
Y2	Condenser thermal-breaker
Y3	Evaporator thermal-breaker
Y5	Defrosting thermal-breaker
Y6	Fan thermal protector
Z	Noise prevention filter

LIMITED WARRANTY

WARRANTY (Warranty valid in USA and Canada)

THREE (3) YEAR PARTS AND LABOR WARRANTY:

Beverage-Air Corporation warrants to the original purchaser of Beverage-Air branded equipment, including all parts thereof, that such equipment is free from defects in material and workmanship, under normal use, proper maintenance, and service as indicated by Beverage-Air installation and operation instructions, for a period of three (3) years from the date of installation, or thirty-nine (39) months from the date of shipment from the manufacturer, whichever is earlier.

ADDITIONAL TWO (2) YEAR COMPRESSOR PART WARRANTY*:

In addition to the warranty set forth above, Beverage-Air warrants the hermetically/semi-hermetically sealed compressor (part only) for an additional TWO (2) years beyond the first THREE (3) years warranty period; not to exceed sixty-three (63) months from the date of shipment from Beverage-Air, provided upon receipt of the compressor, manufacturer examination shows the sealed compressor to be defective. This extended warranty does not cover freight for the replacement compressor or freight for the return of the failed compressor.

* Units shipped after 07/01/2024. Previous warranty applies to units shipped prior.

EXCEPTIONS:

- CT96 and CF3 models carry a ONE (1) year parts and labor warranty, limited to fifteen (15) months from date of shipment from Beverage-Air. These are excluded from additional compressor warranty.
- SR/SF (Slate) models carry a TWO (2) year parts and labor warranty, limited to twenty-seven (27) months from date of shipment from Beverage-Air.
- BZ, VM, CDR, DPCR, MT and Blast Chillers carry a THREE (3) year parts and labor warranty; additional TWO (2) years compressor part only.
- Units installed in Residential applications will be not covered under this warranty. Units are intended for Commercial use only.

Also, this compressor-part only warranty does NOT apply to any electrical controls, condenser, evaporator, fan motors, overload switch, starting relay, capacitors, temperature control, filter/drier, accumulator, refrigeration tubing, wiring harness, labor charges, or supplies which are covered by the warranty above.

Note: 3rd party extended warranties are not covered by this warranty statement.

Normal wear parts, as deemed by Beverage-Air, such as but not exclusive to, light bulbs/lamps and gaskets are not covered by this warranty. For the purpose of this warranty, the original purchaser shall be deemed to mean the individual or company for who the product was originally installed.

Units that utilize variable speed compressor technology can experience nuisance tripping on Class A GFCI outlets which have a trip limit of 4 mA to 6 mA. To avoid this issue in a location that requires GFCI circuit protection, Beverage-Air & Victory recommends using a HUBBELL Model Number GFRST83W 20A Heavy Duty Hospital Grade Self-Test GFCI Receptacle. Nuisance tripping not covered under warranty.

Our obligation under this warranty shall be limited to repairing or replacing, including labor, any part of such product, which proves thus defective. Beverage-Air reserves the right to examine any product claimed to be defective and request photos of the unit prior to dispatching service. Moisture or water damage is not covered under warranty. If service is deemed non-warranty, Beverage-Air reserves the right to bill the end user for service.

The labor warranty shall be for self-contained units only and for standard straight time, which is defined as normal service rate time, for service performed during normal working hours. All warranty labor will be covered at standard time. Any service requested outside of a servicer's normal working hours including weekends and any additional overtime will be at the responsibility of the equipment purchaser. Any part or accessory determined to be defective in the product should be returned to the company within thirty (30) days under the terms of this warranty and must be accompanied by a record of the cabinet model, serial number, and identified with a return material authorization number (RMA#) issued by the manufacturer.

Special installation/applications, including remote locations, are limited in coverage by this warranty. Any installation that requires extra work, and/or travel, to gain access to the unit for service is the sole responsibility of the equipment purchaser.

Improper operation resulting from factors, including but not limited to, improper or negligent cleaning and maintenance, improper installation, low voltage conditions, inadequate wiring, outdoor use (unless otherwise specified) and accidental damage are not manufacturing defects and are strictly the responsibility of the purchaser.

LIMITED WARRANTY (CONTINUED)

With the exception of Blast Chillers, the product is designed for maintaining temperature and not bringing food to a desired temperature and therefore cannot be held responsible for this function under warranty. Units must be in a conditioned environment or warranty will be void. Non-standard use of unit can also be subject to reduced or voided warranty.

Condensing coils must be cleaned at regular intervals as a part of preventative maintenance for optimal performance. Failure to do so is subject to a voided warranty. Although cleaning requirements vary in accordance with operation of various products, Beverage-Air recommends a minimum monthly cleaning.

NO CLAIMS CAN BE MADE AGAINST THIS WARRANTY FOR SPOILAGE OF FOOD, PRODUCTS, LOSS OF SALES OR CONSEQUENTIAL DAMAGES.

THE FOREGOING WARRANTIES ARE EXPRESSLY GIVEN IN LIEU OF ALL OTHER WARRANTIES, EXPRESS, IMPLIED, OR STATUTORY, INCLUDING THE IMPLIED WARRANTIES OF MERCHANTABILITY AND FITNESS FOR A PARTICULAR PURPOSE, WHICH ARE HEREBY DISCLAIMED, ALL OTHER OBLIGATIONS OR LIABILITIES ON OUR PART, AND WE NEITHER ASSUME, NOR AUTHORIZE ANY OTHER PERSON TO ASSUME FOR US, ANY OBLIGATION OR LIABILITY IN CONNECTION WITH THE SALE OF SAID REFRIGERATION UNITS OR ANY PARTS THERE OF.

This warranty shall not be assignable and shall be honored only in so far as the original purchaser. This warranty does not apply outside the limits of the United States of America and Canada, nor does it apply to any part that has been subject to misuse, neglect, alteration, accident, or to any damage caused by transportation, flood, fire, acts of terrorism, or acts of God.

LIMITATION OF LIABILITY:

Beverage-Air Corporation or their affiliates shall not be liable for any indirect, incidental, special or consequential damages, or losses of a commercial nature arising out of malfunction equipment or its parts components thereof, as a result of defects in material or workmanship.

THE ORIGINAL OWNER'S SOLE AND EXCLUSIVE REMEDY AND BEVERAGE-AIR'S SOLE AND EXCLUSIVE LIABILITY SHALL BE LIMITED TO THE REPAIR OR REPLACEMENT OF PARTS OR COMPONENTS CONTAINED IN THE EQUIPMENT IDENTIFIED ABOVE WHICH UNDER NORMAL USE AND SERVICE MALFUNCTION AS A RESULT OF DEFECTS IN MATERIAL OR WORKMANSHIP, SUBJECT TO THE APPLICABLE PROVISIONS AND LIMITATIONS STATED ABOVE.

Note: Additional Terms and Conditions of sale may apply. Notice: Specifications are subject to change without notice. Contact Beverage-Air for specific model agency approval. All prices are ex-works Brookville, PA. July 1, 2024

Warranty Registration

Register your product online at Beverage-Air.com/parts-service or fill out and mail the form below.

Cabinet Model Number: _____ Date Of Installation: _____

Cabinet Serial Number: _____

Location Of Product

Business Name: _____

Business Street: _____

Business City: _____ State: _____ Postal Code: _____

Mail to: Beverage-Air, 3779 Champion Blvd, Winston-Salem, NC 27105

Rev. 02/26

